

! GENERAL INFORMATION

! This price-list is for **SECUTHERM® temperature gauges** with nitrogen (N2) filled system manufactured by:

STIKO Meetapparatenfabriek B.V., RODEN, The Netherlands.

! STIKO® is a manufacturer of instruments since 1963 for measuring temperature and pressure either mechanical and/or electronic e.g. temperature and pressure gauges, PT-100, pressure and temperature, transmitters etc. We develop and manufacture all our instruments to ISO-9001-2000 standards.

! **The mentioned prices are in Euro NETT for delivery EX WORKS, EXCL. PACKING and according to our delivery and payment conditions (see enclosure).**

! Price are under usual reserve.

! To find the total price for **RIGID STEM THERMOMETERS** add the prices of the following:

	EXAMPLE :	PAGE:
1 Basic price (head)	TXR100XA	3
2 Glycerine filling	X? L: TXR100LA	3
3 Temperature range	0 + 250°C	28
4 Bulb length and diameter	100x10 mm, AISI321	8
5 Connection	½"BSP, Type B, AISI304	8-11
6 Electrical device	--	33-39

! To find the total price for **CAPILLARY TUBE THERMOMETERS** add the prices of the following:

	EXAMPLE :	PAGE:
1 Basic price (head)	TXC160XA	18
2 Temperature range	0 + 100°C	28
3 Capill tube	1.500 mm, st.steel	24
4 Bulb length and diameter	150x10 mm, AISI321	25
5 Connection	½"BSP, Type CS3, AISI304	25-27
6 Electrical device	--	
7 Any options	drag pointer	32

! Abbreviations used in this price list: O.D. = ON DEMAND; N.A. = NOT AVAILABLE

! Dimensions used in this price list are in: millimeters (mm).

! Your order will be confirmed by fax.

! Other variations which are not mentioned in this price-list are on demand (if possible).

! CERTIFICATION AND REPAIR SERVICE

! Certificates of Conformity to the company's published specifications are available on request for all STIKO® manufactured products according to EN 10204 2.2.

! Certificates of Calibration for all STIKO® manufactured products are also available. These certificates indicate deviations from standards traceable to N.K.O. or D.K.D. (Dutch/German National Standards). The results are recorded in a certificate which include calibration date, instrument serial number, type number and the N.K.O. or D.K.D. standard used.

! Material Certificates according to EN 10204 3.1.B. for all STIKO® manufactured products are also available. These certificates indicate specifications of the materials used.

! An efficient repair and sparepart service is available at competitive rates for STIKO® products and products of other manufacturers. Instruments for repair should be sent carriage paid and labelled with the senders name and address, together with a brief description of the work required. Within two days after receiving the instruments you will get a full detailed offer for the repair job.

RIGID STEM DIAL THERMOMETERS TYPE TXR

TYPE	DRAWING	DIMENSIONS mm																																															
<p>A</p> <p>TXRxxxXA</p>		<table border="1"> <thead> <tr> <th rowspan="2">DIM.</th> <th colspan="5">CASE DIAMETER</th> </tr> <tr> <th>63</th> <th>80</th> <th>100</th> <th>160</th> <th>250</th> </tr> </thead> <tbody> <tr> <td>A</td> <td>65</td> <td>83</td> <td>101</td> <td>161</td> <td>252</td> </tr> <tr> <td>B</td> <td>38</td> <td>37</td> <td>45</td> <td>45</td> <td>55</td> </tr> <tr> <td>C</td> <td>13</td> <td>13</td> <td>13</td> <td>13</td> <td>13</td> </tr> </tbody> </table>	DIM.	CASE DIAMETER					63	80	100	160	250	A	65	83	101	161	252	B	38	37	45	45	55	C	13	13	13	13	13																		
DIM.	CASE DIAMETER																																																
	63	80	100	160	250																																												
A	65	83	101	161	252																																												
B	38	37	45	45	55																																												
C	13	13	13	13	13																																												
<p>E</p> <p>TXRxxxXE</p>		<table border="1"> <thead> <tr> <th rowspan="2">DIM.</th> <th colspan="5">CASE DIAMETER</th> </tr> <tr> <th>63</th> <th>80</th> <th>100</th> <th>160</th> <th>250</th> </tr> </thead> <tbody> <tr> <td>A</td> <td>65</td> <td>83</td> <td>101</td> <td>161</td> <td>252</td> </tr> <tr> <td>B</td> <td>38</td> <td>37</td> <td>45</td> <td>45</td> <td>55</td> </tr> </tbody> </table>	DIM.	CASE DIAMETER					63	80	100	160	250	A	65	83	101	161	252	B	38	37	45	45	55																								
DIM.	CASE DIAMETER																																																
	63	80	100	160	250																																												
A	65	83	101	161	252																																												
B	38	37	45	45	55																																												
<p>T</p> <p>TXRxxxXT-x</p>		<table border="1"> <thead> <tr> <th rowspan="2">DIM.</th> <th colspan="5">CASE DIAMETER</th> </tr> <tr> <th>63</th> <th>80</th> <th>100</th> <th>160</th> <th>250</th> </tr> </thead> <tbody> <tr> <td>A</td> <td>65</td> <td>83</td> <td>101</td> <td>161</td> <td>252</td> </tr> <tr> <td>B</td> <td>38</td> <td>37</td> <td>45</td> <td>45</td> <td>55</td> </tr> <tr> <td>C</td> <td>13</td> <td>13</td> <td>13</td> <td>13</td> <td>13</td> </tr> </tbody> </table>	DIM.	CASE DIAMETER					63	80	100	160	250	A	65	83	101	161	252	B	38	37	45	45	55	C	13	13	13	13	13																		
DIM.	CASE DIAMETER																																																
	63	80	100	160	250																																												
A	65	83	101	161	252																																												
B	38	37	45	45	55																																												
C	13	13	13	13	13																																												
<p>F</p> <p>TXRxxxXF</p>		<table border="1"> <thead> <tr> <th rowspan="2">DIM.</th> <th colspan="5">CASE DIAMETER</th> </tr> <tr> <th>63</th> <th>80</th> <th>100</th> <th>160</th> <th>250</th> </tr> </thead> <tbody> <tr> <td>A</td> <td>65</td> <td>83</td> <td>101</td> <td>161</td> <td>252</td> </tr> <tr> <td>B</td> <td>41</td> <td>40</td> <td>51</td> <td>51</td> <td>57</td> </tr> <tr> <td>D</td> <td>86</td> <td>110</td> <td>132</td> <td>196</td> <td>285</td> </tr> <tr> <td>F</td> <td>5</td> <td>5</td> <td>5</td> <td>5</td> <td>2</td> </tr> <tr> <td>H</td> <td>3.5</td> <td>4</td> <td>5.5</td> <td>6</td> <td>6</td> </tr> <tr> <td>P</td> <td>75</td> <td>95</td> <td>116</td> <td>178</td> <td>270</td> </tr> </tbody> </table>	DIM.	CASE DIAMETER					63	80	100	160	250	A	65	83	101	161	252	B	41	40	51	51	57	D	86	110	132	196	285	F	5	5	5	5	2	H	3.5	4	5.5	6	6	P	75	95	116	178	270
DIM.	CASE DIAMETER																																																
	63	80	100	160	250																																												
A	65	83	101	161	252																																												
B	41	40	51	51	57																																												
D	86	110	132	196	285																																												
F	5	5	5	5	2																																												
H	3.5	4	5.5	6	6																																												
P	75	95	116	178	270																																												

SECUTHERM® RIGID STEM DIAL THERMOMETERS

Type TXR, with stainless steel case according to EN 13190

STANDARD MODEL:

CASE : bayonet lock, AISI304/1.4301, IP-65
STEM - BULB : AISI321/1.4541, see page 8 - 11
WINDOW : mineral glass 4 mm
DIAL : aluminium, black figures on white
POINTER : aluminium, black
CONNECTION : see page 8 - 11
RANGES : from -200 upto +800°C, see page 29 - 30

EXAMPLE:

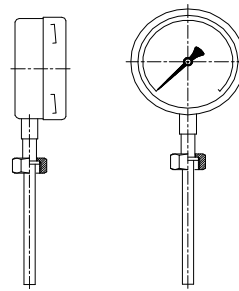

TXR100XA

OVERLOAD : up to 30% F.S.
 (but max. 800°C)
ACCURACY : ±1% F.S. / class 1
MOVEMENT : brass
OPTIONS : see page 33
CONTACTS : see page 34-45
PT-100 : see page 44
TRANSMITTER : see page 44

TYPE	MODEL	CASE DIAMETER (Ø in mm)				
		63	80	100	160	250
A 1130		TXR063XA	TXR080XA	TXR100XA	TXR160XA	TXR250XA
E 1131		TXR063XE	TXR080XE	TXR100XE	TXR160XE	TXR250XE
T 1133-x (x=A,B,C or D)		TXR063XT-x	TXR080XT-x	TXR100XT-x	TXR160XT-x	TXR250XT-x
F 1138		TXR063XF	TXR080XF	TXR100XF	TXR160XF	TXR250XF
OPTION		EXTRA COSTS				
Lx	LIQUID FILLED CASE: GLYCERINE (in combination with electrical device: OIL, (see page 22)	TXR063Lx	TXR080Lx	TXR100Lx	TXR160Lx	TXR250Lx

EVERY ANGLE DIAL THERMOMETERS TYPE TXR

TYPE	DRAWING	DIMENSIONS mm																													
<p>A</p> <p><i>knee joint 180°</i></p>		<table border="1"> <thead> <tr> <th rowspan="2">DIM.</th> <th colspan="5">CASE DIAMETER</th> </tr> <tr> <th>63</th> <th>80</th> <th>100</th> <th>160</th> <th>250</th> </tr> </thead> <tbody> <tr> <td>A</td> <td>65</td> <td>83</td> <td>101</td> <td>161</td> <td>252</td> </tr> <tr> <td>B</td> <td>38</td> <td>37</td> <td>45</td> <td>45</td> <td>55</td> </tr> <tr> <td>C</td> <td>13</td> <td>13</td> <td>13</td> <td>13</td> <td>13</td> </tr> </tbody> </table>	DIM.	CASE DIAMETER					63	80	100	160	250	A	65	83	101	161	252	B	38	37	45	45	55	C	13	13	13	13	13
DIM.	CASE DIAMETER																														
	63	80	100	160	250																										
A	65	83	101	161	252																										
B	38	37	45	45	55																										
C	13	13	13	13	13																										
<p>E</p> <p><i>knee joint 180°</i></p>		<table border="1"> <thead> <tr> <th rowspan="2">DIM.</th> <th colspan="5">CASE DIAMETER</th> </tr> <tr> <th>63</th> <th>80</th> <th>100</th> <th>160</th> <th>250</th> </tr> </thead> <tbody> <tr> <td>A</td> <td>65</td> <td>83</td> <td>101</td> <td>161</td> <td>252</td> </tr> <tr> <td>B</td> <td>38</td> <td>37</td> <td>45</td> <td>45</td> <td>55</td> </tr> </tbody> </table>	DIM.	CASE DIAMETER					63	80	100	160	250	A	65	83	101	161	252	B	38	37	45	45	55						
DIM.	CASE DIAMETER																														
	63	80	100	160	250																										
A	65	83	101	161	252																										
B	38	37	45	45	55																										
<p>A</p> <p><i>knee joint 360°</i></p>		<table border="1"> <thead> <tr> <th rowspan="2">DIM.</th> <th colspan="5">CASE DIAMETER</th> </tr> <tr> <th>63</th> <th>80</th> <th>100</th> <th>160</th> <th>250</th> </tr> </thead> <tbody> <tr> <td>A</td> <td>65</td> <td>83</td> <td>101</td> <td>161</td> <td>252</td> </tr> <tr> <td>B</td> <td>38</td> <td>37</td> <td>45</td> <td>45</td> <td>55</td> </tr> <tr> <td>C</td> <td>13</td> <td>13</td> <td>13</td> <td>13</td> <td>13</td> </tr> </tbody> </table>	DIM.	CASE DIAMETER					63	80	100	160	250	A	65	83	101	161	252	B	38	37	45	45	55	C	13	13	13	13	13
DIM.	CASE DIAMETER																														
	63	80	100	160	250																										
A	65	83	101	161	252																										
B	38	37	45	45	55																										
C	13	13	13	13	13																										
<p>E</p> <p><i>knee joint 360°</i></p>		<table border="1"> <thead> <tr> <th rowspan="2">DIM.</th> <th colspan="5">CASE DIAMETER</th> </tr> <tr> <th>63</th> <th>80</th> <th>100</th> <th>160</th> <th>250</th> </tr> </thead> <tbody> <tr> <td>A</td> <td>65</td> <td>83</td> <td>101</td> <td>161</td> <td>252</td> </tr> <tr> <td>B</td> <td>38</td> <td>37</td> <td>45</td> <td>45</td> <td>55</td> </tr> </tbody> </table>	DIM.	CASE DIAMETER					63	80	100	160	250	A	65	83	101	161	252	B	38	37	45	45	55						
DIM.	CASE DIAMETER																														
	63	80	100	160	250																										
A	65	83	101	161	252																										
B	38	37	45	45	55																										

SECUTHERM® EVERY ANGLE DIAL THERMOMETERS

Type TXR, with KNEE JOINT and stainless steel case acc. to EN 13190

STANDARD MODEL:

CASE : bayonet lock, AISI304/1.4301, IP-65

KNEE JOINT : AISI304/1.4301, 180° or 360° see below

180° : bending only

360° : bending and turning

STEM - BULB : AISI321/1.4541, see page 8 - 11

WINDOW : mineral glass 4 mm

DIAL : aluminium, black figures on white

POINTER : aluminium, black

EXAMPLE:

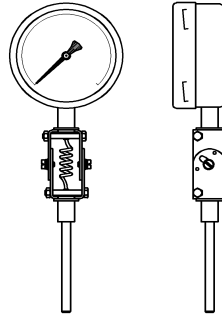

TXR100XA + K360°

CONNECTION : see page 8 - 11

RANGES : -200 upto +800°C
see page 29 - 30

OVERLOAD : up to 30% F.S.
(but max. 800°C)

ACCURACY : ±1% F.S. / class 1

MOVEMENT : brass

OPTIONS : see page 33

CONTACTS : see page 34 - 44

TYPE	MODEL	CASE DIAMETER (Ø in mm)				
		63	80	100	160	250
A 180°		TXR063XA+K180°	TXR080XA+K180°	TXR100XA+K180°	TXR160XA+K180°	TXR250XA+K180°
E 180°		TXR063XE+K180°	TXR080XE+K180°	TXR100XE+K180°	TXR160XE+K180°	TXR250XE+K180°
A 360°		TXR063XA+K360°	TXR080XA+K360°	TXR100XA+K360°	TXR160XA+K360°	TXR250XA+K360°
E 360°		TXR063XE+K360°	TXR080XE+K360°	TXR100XE+K360°	TXR160XE+K360°	TXR250XE+K360°
OPTION		EXTRA COSTS				
Lx	LIQUID FILLED CASE: GLYCERINE (in combination with electrical device: OIL, (see page 22))	TXR063Lx+K	TXR080Lx+K	TXR100Lx+K	TXR160Lx+K	TXR250Lx+K

BULB LENGTH AND DIAMETER FOR TYPE TXR

TYPE	STANDARD MODEL	bulb diameter Ø d	EXTRA COSTS per 100 mm STAINLESS STEEL AISI321/1.4541
A <i>plain stem</i>		9, 10, 12	per 100 mm
		6, 6.35, 8, 11, 12.5, 13, 14	per 100 mm
		7, 15, 16, 17, 18, 20	per 100 mm
FOR SHORTEST SENSITIVE PART "Ls": SEE PAGE 32		FOR OPTIONS ON BULB LENGTH AND DIAMETER: SEE PAGE 11	

CONNECTIONS FOR RIGID STEM MODELS TYPE TXR

TYPE	MODEL FOR OPTIONS ON CONNECTIONS: SEE PAGE 11	DIMENSIONS				EXTRA COSTS STAINLESS STEEL AISI304/1.4301	
		connection	HEX-1	HEX-2	T		d max
B <i>coupling nut (standard model)</i>		1/4" BSP	22	-	7	Ø 8	
		3/8" BSP	27	-	9	Ø 11	
		1/2" BSP	27	-	9	Ø 15	
		3/4" BSP	32	-	9	Ø 20	
		1" BSP	41	-	13	Ø 20	
		M18x1.5	27	-	8	Ø 12	
		M20x1.5	27	-	9	Ø 14	
BL <i>coupling nut (long model)</i>		1/2" BSP	27	-	14	Ø 15	
		3/4" BSP	32	-	16	Ø 20	
		1" BSP	41	-	18	Ø 20	
C <i>fixed nipple (standard model)</i>		1/4" BSP	17	-	12	Ø 8	
		3/8" BSP	22	-	12	Ø 11	
		1/2" BSP	22	-	14	Ø 15	
		3/4" BSP	30	-	16	Ø 20	
		1" BSP	36	-	18	Ø 20	
		1/4" NPT	17	-	14	Ø 8	
		1/2" NPT	22	-	20	Ø 15	
		3/4" NPT	30	-	20	Ø 20	
		1" NPT	36	-	25	Ø 20	
		M18x1.5	22	-	12	Ø 12	
CL <i>fixed nipple (long model)</i>		1/2" BSP	22	-	20	Ø 15	
		3/4" BSP	30	-	20	Ø 20	
		1" BSP	36	-	25	Ø 20	

CONNECTIONS FOR RIGID STEM MODELS TYPE TXR

TYPE	MODEL FOR OPTIONS ON CONNECTIONS: SEE PAGE 11	DIMENSIONS				EXTRA COSTS	
		connection	HEX-1	HEX-2	T	d max	STAINLESS STEEL AISI304/1.4301
A 04 turning nipple (standard model)		1/4" BSP	17	-	12	Ø 8	
		3/8" BSP	22	-	12	Ø 11	
		1/2" BSP	22	-	14	Ø 15	
		3/4" BSP	30	-	16	Ø 20	
		1" BSP	36	-	18	Ø 20	
		M18x1.5	22	-	12	Ø 12	
		M20x1.5	22	-	14	Ø 14	
AL04 turning nipple (long model)		1/2" BSP	22	-	20	Ø 15	
		3/4" BSP	30	-	20	Ø 20	
		1" BSP	36	-	25	Ø 20	
B 01 coupling nut + double nipple	<p style="text-align: center;">THREAD BETWEEN HEX-1 and HEX-2: 1/2" BSP</p>	1/4" BSP	27	22	12	Ø 8	
		3/8" BSP	27	22	12	Ø 11	
		1/2" BSP	27	22	14	Ø 15	
		3/4" BSP	27	27	16	Ø 20	
		1" BSP	27	36	18	Ø 20	
		1/4" NPT	27	22	14	Ø 8	
		1/2" NPT	27	22	20	Ø 15	
		3/4" NPT	27	27	20	Ø 20	
		1" NPT	27	36	25	Ø 20	
		M18x1.5	27	22	12	Ø 12	
		M20x1.5	27	22	14	Ø 14	
CS 3 adjustable connection, sliding on stem	<p style="text-align: center;">THREAD BETWEEN HEX-1 and HEX-2: 1/2" BSP</p>	1/4" BSP	22	27	12	Ø 8	
		3/8" BSP	22	27	12	Ø 11	
		1/2" BSP	22	27	14	Ø 15	
		3/4" BSP	22	32	16	Ø 20	
		1" BSP	22	36	18	Ø 20	
		1/4" NPT	22	27	14	Ø 8	
		1/2" NPT	22	27	20	Ø 15	
		3/4" NPT	22	27	20	Ø 20	
		1" NPT	22	36	25	Ø 20	
		M18x1.5	22	27	12	Ø 12	
		M20x1.5	22	27	14	Ø 14	
M24x1.5	22	27	14	Ø 18			

CONNECTIONS FOR RIGID STEM MODELS TYPE TXR

TYPE	MODEL	DIMENSIONS			EXTRA COSTS
		L	d-1	d-2	STAINLESS STEEL
					AISI321/1.4541
S <i>surface bulb: fixed type</i>		-	-	-	
SA <i>surface bulb: adjustable type</i>	<p>THREAD BETWEEN HEX-1 AND HEX-2: 1/2" BSP</p>	-	-	-	
HA <i>helical air bulb</i>		-	-	-	
HP <i>with handle and point</i>		1000	10 12	22	
		1000	14 16	22	
		1000	18	22	

SANITARY CONNECTIONS FOR RIGID STEM MODELS TYPE TXR

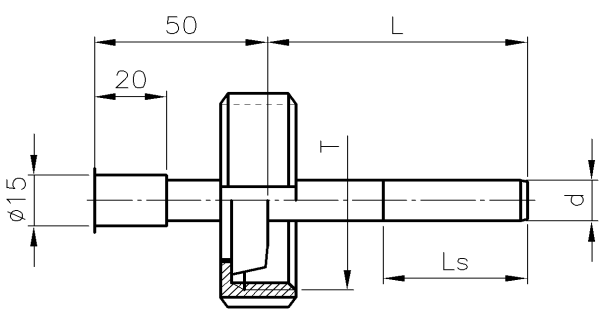
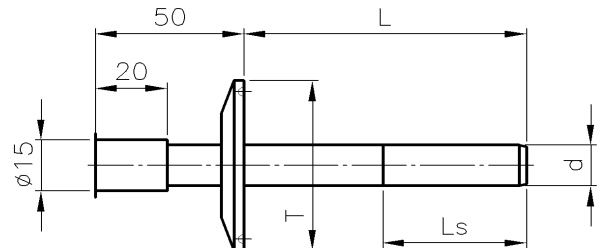
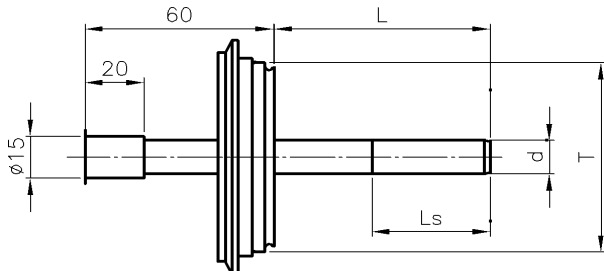
TYPE	MODEL WITH POLISHED BULB	DIMENSIONS		EXTRA COSTS
		connection	T	STAINLESS STEEL AISI316/1.4401
CM <i>acc. to DIN 11851</i>	 <p style="text-align: center;">(also available in SMS, RJT, IDF etc.)</p>	1" - NW25	rd 52x1/6	
		1 1/2" - NW40	rd 65x1/6	
		2" - NW50	rd 78x1/6	
		3" - NW75	rd 104x1/6	
TC <i>TRI CLAMP acc. to ISO 2852</i>		1" - NW25	Ø 50.5	
		1 1/2" - NW40	Ø 50.5	
		2" - NW50	Ø 64	
TV <i>Varivent® In-Line</i>		NW 10-15	Ø 31	ON DEMAND
		NW 25-32	Ø 50	
		NW 40-50	Ø 68	

OPTIONS FOR BULB AND STEM

OPTION		EXTRA COSTS
		PER 100 MM
BULB AND STEM AISI316/1.4401	for diameter 6, 8, 9, 10, 12, 13, 14, 15, 16, 18	
BULB AND STEM POLISHED (MECHANICAL)	for all diameters	
BULB AND STEM PTFE® LINING (max.250° C)	MAXIMUM 1000 mm (longer: ON DEMAND)	first 100 mm:
BULB AND STEM HALAR® COATED (max.120° C)		per 100 mm extra:

ROOM THERMOMETERS TYPE RTX

TYPE	DRAWING	DIMENSIONS mm																																																					
<p style="font-size: 2em; font-weight: bold;">R</p> <p>RTXxxxXR</p>		<table border="1" style="margin-left: auto; margin-right: auto;"> <thead> <tr> <th rowspan="2">DIM.</th> <th colspan="5">CASE DIAMETER</th> </tr> <tr> <th>63</th> <th>80</th> <th>100</th> <th>160</th> <th>250</th> </tr> </thead> <tbody> <tr> <td>A</td> <td>65</td> <td>83</td> <td>101</td> <td>161</td> <td>252</td> </tr> <tr> <td>B</td> <td>41</td> <td>40</td> <td>51</td> <td>51</td> <td>57</td> </tr> <tr> <td>D</td> <td>86</td> <td>110</td> <td>132</td> <td>196</td> <td>285</td> </tr> <tr> <td>F</td> <td>5</td> <td>5</td> <td>5</td> <td>5</td> <td>2</td> </tr> <tr> <td>H</td> <td>3.5</td> <td>4</td> <td>5.5</td> <td>6</td> <td>6</td> </tr> <tr> <td>P</td> <td>75</td> <td>95</td> <td>116</td> <td>178</td> <td>270</td> </tr> </tbody> </table>	DIM.	CASE DIAMETER					63	80	100	160	250	A	65	83	101	161	252	B	41	40	51	51	57	D	86	110	132	196	285	F	5	5	5	5	2	H	3.5	4	5.5	6	6	P	75	95	116	178	270						
DIM.	CASE DIAMETER																																																						
	63	80	100	160	250																																																		
A	65	83	101	161	252																																																		
B	41	40	51	51	57																																																		
D	86	110	132	196	285																																																		
F	5	5	5	5	2																																																		
H	3.5	4	5.5	6	6																																																		
P	75	95	116	178	270																																																		
<p style="font-size: 2em; font-weight: bold;">B</p> <p>RTXxxxXB</p>		<table border="1" style="margin-left: auto; margin-right: auto;"> <thead> <tr> <th rowspan="2">DIM.</th> <th colspan="5">CASE DIAMETER</th> </tr> <tr> <th>63</th> <th>80</th> <th>100</th> <th>160</th> <th>250</th> </tr> </thead> <tbody> <tr> <td>A</td> <td>65</td> <td>83</td> <td>101</td> <td>161</td> <td>252</td> </tr> <tr> <td>B</td> <td>41</td> <td>40</td> <td>51</td> <td>51</td> <td>57</td> </tr> <tr> <td>C</td> <td>13</td> <td>13</td> <td>13</td> <td>13</td> <td>13</td> </tr> <tr> <td>D</td> <td>86</td> <td>110</td> <td>132</td> <td>196</td> <td>285</td> </tr> <tr> <td>F</td> <td>5</td> <td>5</td> <td>5</td> <td>5</td> <td>2</td> </tr> <tr> <td>H</td> <td>3.5</td> <td>4</td> <td>5.5</td> <td>6</td> <td>6</td> </tr> <tr> <td>P</td> <td>75</td> <td>95</td> <td>116</td> <td>178</td> <td>270</td> </tr> </tbody> </table>	DIM.	CASE DIAMETER					63	80	100	160	250	A	65	83	101	161	252	B	41	40	51	51	57	C	13	13	13	13	13	D	86	110	132	196	285	F	5	5	5	5	2	H	3.5	4	5.5	6	6	P	75	95	116	178	270
DIM.	CASE DIAMETER																																																						
	63	80	100	160	250																																																		
A	65	83	101	161	252																																																		
B	41	40	51	51	57																																																		
C	13	13	13	13	13																																																		
D	86	110	132	196	285																																																		
F	5	5	5	5	2																																																		
H	3.5	4	5.5	6	6																																																		
P	75	95	116	178	270																																																		

SECUTHERM® ROOM THERMOMETERS

Type RTX, with stainless steel case according to EN 13190

STANDARD MODEL

CASE	: bayonet lock, AISI304/1.4301, type R with vent holes (for indoor use), type B: IP65	RANGES	: for measuring ambient temperatures: minimum -50 upto +80°C, see page 29
STEM AND BULB	: AISI321/1.4541, for type R: bulb inside case and for type plain stem type A or helical air-bulb type HA (see below)	OVERLOAD	: up to 30% F.S. (but max. 80°C)
WINDOW	: mineral glass 4 mm	ACCURACY	: ±1% F.S. / class 1
DIAL	: aluminium, black figures on white	MOVEMENT	: brass
POINTER	: aluminium, black	OPTIONS	: see page 33, electrical device: page 34 - 45

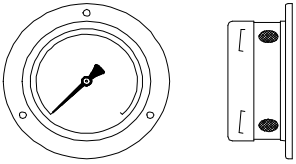
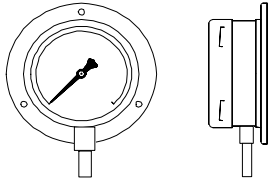
TYPE	MODEL	CASE DIAMETER (R in mm)				
		063	080	100	160	250
R 1142		N.A.	N.A.	RTX100XR	RTX160XR	RTX250XR
B 1142-SPECIAL		RTX063XB	RTX080XB	RTX100XB	RTX160XB	RTX250XB
OPTION		EXTRA COSTS				
LB not for type R	LIQUID FILLED CASE: GLYCERINE (in combination with electrical device: OIL, see page 45)	RTX063LB	RTX080LB	RTX100LB	RTX160LB	RTX250LB

BULB TYPES FOR TYPE B

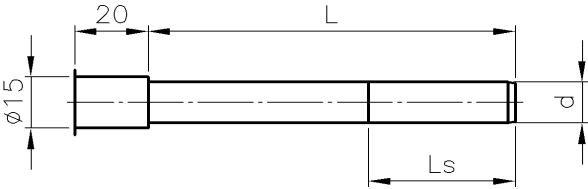
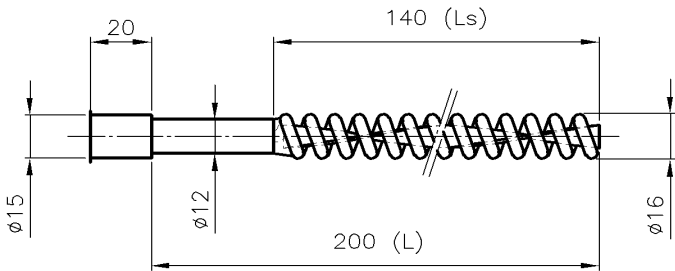
TYPE	MODEL	BULB AISI321/1.4541	EXTRA COSTS
A PLAIN STEM	 <p>FOR STANDARD SENSITIVE PART "Ls": SEE PAGE 32</p>	L=60 d=12 Ls=35	STANDARD
HA HELICAL AIR BULB		L=200	

DIESEL EXHAUST DIAL THERMOMETERS

TYPE	DRAWING	DIMENSIONS mm																													
<p style="font-size: 2em; font-weight: bold;">A</p> <p>TXRxxxLA- DIESEL</p>		<table border="1" style="margin-left: auto; margin-right: auto;"> <thead> <tr> <th rowspan="2">DIM.</th> <th colspan="5">CASE DIAMETER</th> </tr> <tr> <th>63</th> <th>80</th> <th>100</th> <th>160</th> <th>250</th> </tr> </thead> <tbody> <tr> <td>A</td> <td>65</td> <td>83</td> <td>101</td> <td>161</td> <td>252</td> </tr> <tr> <td>B</td> <td>38</td> <td>37</td> <td>45</td> <td>45</td> <td>55</td> </tr> <tr> <td>C</td> <td>13</td> <td>13</td> <td>13</td> <td>13</td> <td>13</td> </tr> </tbody> </table>	DIM.	CASE DIAMETER					63	80	100	160	250	A	65	83	101	161	252	B	38	37	45	45	55	C	13	13	13	13	13
DIM.	CASE DIAMETER																														
	63	80	100	160	250																										
A	65	83	101	161	252																										
B	38	37	45	45	55																										
C	13	13	13	13	13																										
<p style="font-size: 2em; font-weight: bold;">E</p> <p>TXRxxxLE- DIESEL</p>		<table border="1" style="margin-left: auto; margin-right: auto;"> <thead> <tr> <th rowspan="2">DIM.</th> <th colspan="5">CASE DIAMETER</th> </tr> <tr> <th>63</th> <th>80</th> <th>100</th> <th>160</th> <th>250</th> </tr> </thead> <tbody> <tr> <td>A</td> <td>65</td> <td>83</td> <td>101</td> <td>161</td> <td>252</td> </tr> <tr> <td>B</td> <td>38</td> <td>37</td> <td>45</td> <td>45</td> <td>55</td> </tr> </tbody> </table>	DIM.	CASE DIAMETER					63	80	100	160	250	A	65	83	101	161	252	B	38	37	45	45	55						
DIM.	CASE DIAMETER																														
	63	80	100	160	250																										
A	65	83	101	161	252																										
B	38	37	45	45	55																										
<p style="font-size: 2em; font-weight: bold;">+AVS</p> <p>TXRxxxLA- DIESEL+AVS</p>		<table border="1" style="margin-left: auto; margin-right: auto;"> <thead> <tr> <th rowspan="2">DIM.</th> <th colspan="5">CASE DIAMETER</th> </tr> <tr> <th>63</th> <th>80</th> <th>100</th> <th>160</th> <th>250</th> </tr> </thead> <tbody> <tr> <td>A</td> <td>65</td> <td>83</td> <td>101</td> <td>161</td> <td>252</td> </tr> <tr> <td>B</td> <td>38</td> <td>37</td> <td>45</td> <td>45</td> <td>55</td> </tr> <tr> <td>C</td> <td>13</td> <td>13</td> <td>13</td> <td>13</td> <td>13</td> </tr> </tbody> </table>	DIM.	CASE DIAMETER					63	80	100	160	250	A	65	83	101	161	252	B	38	37	45	45	55	C	13	13	13	13	13
DIM.	CASE DIAMETER																														
	63	80	100	160	250																										
A	65	83	101	161	252																										
B	38	37	45	45	55																										
C	13	13	13	13	13																										

SECUTHERM® DIESEL EXHAUST DIAL THERMOMETERS

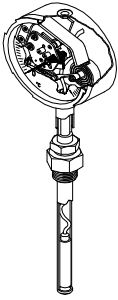
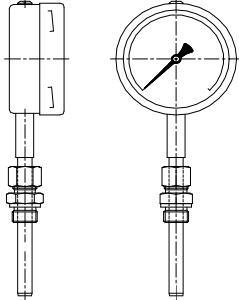
 <p>3-D view SECUTHERM® DIESEL</p>	GENERAL INFORMATION	 <p>SECUTHERM® DIESEL THERMOMETER</p>
	<p>DIAL THERMOMETERS SPECIAL DESIGNED FOR:</p> <ul style="list-style-type: none"> - Diesel engines; for monitoring: exhaust gas, cooling water, oil, air-inlet temperatures - Compressors, - Turbochargers, - other machines subjected to severe vibrations - max. temperature 800°C 	

Type TXR-DIESEL, with stainless steel case according to EN 13190

STANDARD MODEL:

CASE	: bayonet lock, AISI304/1.4301, IP-67 silicone oil filled	RANGES	: 0+600, 0+650, +50/+650°C, see page 30
STEM AND BULB	: 150 x Ø12 mm, AISI321/1.4541, see page 16	ADJUSTMENT	: +/- 6% F.S. with adjustment screw
WINDOW	: mineral glass 4 mm	OVERLOAD	: up to 30% F.S. (but max. 800°C)
DIAL	: aluminium, black figures on white	ACCURACY	: ±1% F.S. / class 1
POINTER	: aluminium, black	MOVEMENT	: brass
CONNECTION	: AISI304/1.4301, see page 16 - 17	OPTIONS	: see page below + page 33

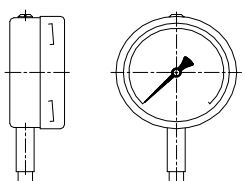
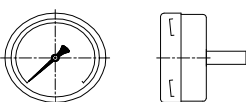
TYPE	MODEL	CASE DIAMETER (Ø in mm)		
		63	80	100
A 1130		TXR063LA-DIESEL	TXR080LA-DIESEL	TXR100LA-DIESEL
		E 1131		TXR063LE-DIESEL

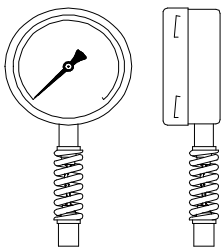
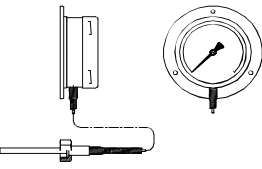
OPTION	EXAMPLE:	CASE DIAMETER (Ø in mm)		
		63	80	100
+AVS ANTI-VIBRATION SPRING		TXR063Lx-DIESEL+AVS	TXR080Lx-DIESEL+AVS	TXR100Lx-DIESEL+AVS
CAPILLARY CAPILLARY TYPE DIESEL THERMOMETER		SEE PAGE 19	SEE PAGE 19	SEE PAGE 19

BULB LENGTH AND DIAMETER FOR TYPE TXR-DIESEL

TYPE	STANDARD MODEL	bulb and stem L=150 mm x Ø d AISI321/1.4541	EXTRA COSTS per 50 mm extra
A <i>plain stem</i>		10 and 12	
		13 and 14	
		16 and 18	

CONNECTIONS FOR TYPE TXR-DIESEL

TYPE	MODEL	DIMENSIONS					EXTRA COSTS
		connection	HEX-1	HEX-2	T	d max	
B <i>coupling nut (standard model)</i>		1/2"BSP	27	-	9	Ø 15	
		3/4"BSP	32	-	9	Ø 20	
		1"BSP	41	-	13	Ø 20	
		M18x1.5	27	-	8	Ø 12	
		M20x1.5	27	-	9	Ø 14	
		M24x1.5	32	-	9	Ø 18	
BL <i>coupling nut (long model)</i>		1/2"BSP	27	-	14	Ø15	
		3/4"BSP	32	-	16	Ø 20	
		1"BSP	41	-	18	Ø 20	
B 01 <i>coupling nut + double nipple</i>	<p>THREAD BETWEEN HEX-1 AND HEX-2: 1/2"BSP</p>	1/2"BSP	27	22	14	Ø15	
		3/4"BSP	27	27	16	Ø 20	
		1"BSP	27	36	18	Ø 20	
		1/2"NPT	27	22	20	Ø 15	
		3/4"NPT	27	27	20	Ø 20	
		1"NPT	27	36	25	Ø 20	
		M18x1.5	27	22	12	Ø 12	
		M20x1.5	27	22	14	Ø 14	
		M24x1.5	27	27	14	Ø 18	

CONNECTIONS FOR TYPE TXR-DIESEL

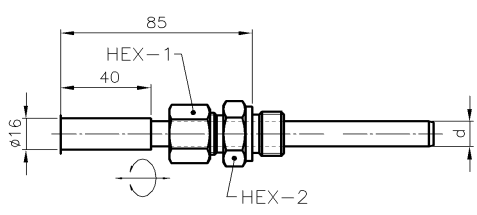
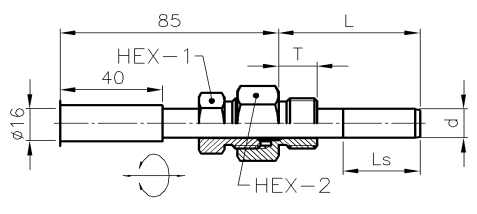
TYPE	MODEL	DIMENSIONS				EXTRA COSTS	
		connection	HEX-1	HEX-2	T		d max
CS 3 adjustable connection, sliding on stem STEEL	 <p style="text-align: center;">THREAD BETWEEN HEX-1 and HEX-2: 1/2" BSP</p>	1/2" BSP only for d=Ø10 and Ø12	22	27	14	Ø 10 and Ø 12	
		3/4" BSP only for d=Ø10, Ø12 and Ø16	22	32	16	Ø 10, Ø12 and Ø16	
CS 3 adjustable connection, sliding on stem AISI304/1.4301	 <p style="text-align: center;">THREAD BETWEEN HEX-1 and HEX-2: 1/2" BSP</p>	1/2" BSP	22	27	14	Ø 15	
		3/4" BSP	22	32	16	Ø 20	
		1" BSP	22	36	18	Ø 20	
		1/2" NPT	22	27	20	Ø 15	
		3/4" NPT	22	32	20	Ø 20	
		1" NPT	22	36	25	Ø 20	
		M18x1.5	22	27	12	Ø12	
		M20x1.5	22	27	14	Ø 14	
		M24x1.5	22	27	14	Ø 18	

NOTE: FOR POCKETS AND THERMOWELLS; SEE PAGE 46 -

CAPILLARY DIAL THERMOMETERS TYPE TXC

TYPE	DRAWING	DIMENSIONS mm																																															
A <i>TXCxxxXA</i>		<table border="1" style="margin-left: auto; margin-right: auto;"> <thead> <tr> <th rowspan="2">DIM.</th> <th colspan="5">CASE DIAMETER</th> </tr> <tr> <th>63</th> <th>80</th> <th>100</th> <th>160</th> <th>250</th> </tr> </thead> <tbody> <tr> <td>A</td> <td>65</td> <td>83</td> <td>101</td> <td>161</td> <td>252</td> </tr> <tr> <td>B</td> <td>38</td> <td>37</td> <td>45</td> <td>45</td> <td>55</td> </tr> <tr> <td>C</td> <td>13</td> <td>13</td> <td>13</td> <td>13</td> <td>13</td> </tr> </tbody> </table>	DIM.	CASE DIAMETER					63	80	100	160	250	A	65	83	101	161	252	B	38	37	45	45	55	C	13	13	13	13	13																		
DIM.	CASE DIAMETER																																																
	63	80	100	160	250																																												
A	65	83	101	161	252																																												
B	38	37	45	45	55																																												
C	13	13	13	13	13																																												
B <i>TXCxxxXB</i>		<table border="1" style="margin-left: auto; margin-right: auto;"> <thead> <tr> <th rowspan="2">DIM.</th> <th colspan="5">CASE DIAMETER</th> </tr> <tr> <th>63</th> <th>80</th> <th>100</th> <th>160</th> <th>250</th> </tr> </thead> <tbody> <tr> <td>A</td> <td>65</td> <td>83</td> <td>101</td> <td>161</td> <td>252</td> </tr> <tr> <td>B</td> <td>41</td> <td>40</td> <td>51</td> <td>51</td> <td>57</td> </tr> <tr> <td>C</td> <td>13</td> <td>13</td> <td>13</td> <td>13</td> <td>13</td> </tr> <tr> <td>D</td> <td>86</td> <td>110</td> <td>132</td> <td>196</td> <td>285</td> </tr> <tr> <td>H</td> <td>3.5</td> <td>4</td> <td>5.5</td> <td>6</td> <td>6</td> </tr> <tr> <td>P</td> <td>75</td> <td>95</td> <td>116</td> <td>178</td> <td>270</td> </tr> </tbody> </table>	DIM.	CASE DIAMETER					63	80	100	160	250	A	65	83	101	161	252	B	41	40	51	51	57	C	13	13	13	13	13	D	86	110	132	196	285	H	3.5	4	5.5	6	6	P	75	95	116	178	270
DIM.	CASE DIAMETER																																																
	63	80	100	160	250																																												
A	65	83	101	161	252																																												
B	41	40	51	51	57																																												
C	13	13	13	13	13																																												
D	86	110	132	196	285																																												
H	3.5	4	5.5	6	6																																												
P	75	95	116	178	270																																												
D <i>TXCxxxXD</i>		<table border="1" style="margin-left: auto; margin-right: auto;"> <thead> <tr> <th rowspan="2">DIM.</th> <th colspan="5">CASE DIAMETER</th> </tr> <tr> <th>63</th> <th>80</th> <th>100</th> <th>160</th> <th>250</th> </tr> </thead> <tbody> <tr> <td>A</td> <td>65</td> <td>83</td> <td>101</td> <td>161</td> <td>252</td> </tr> <tr> <td>B</td> <td>33</td> <td>29</td> <td>31</td> <td>32</td> <td>45</td> </tr> <tr> <td>C</td> <td>13</td> <td>13</td> <td>13</td> <td>13</td> <td>13</td> </tr> <tr> <td>D</td> <td>86</td> <td>110</td> <td>132</td> <td>196</td> <td>285</td> </tr> <tr> <td>H</td> <td>3.5</td> <td>4</td> <td>5.5</td> <td>6</td> <td>6</td> </tr> <tr> <td>P</td> <td>75</td> <td>95</td> <td>116</td> <td>178</td> <td>270</td> </tr> </tbody> </table>	DIM.	CASE DIAMETER					63	80	100	160	250	A	65	83	101	161	252	B	33	29	31	32	45	C	13	13	13	13	13	D	86	110	132	196	285	H	3.5	4	5.5	6	6	P	75	95	116	178	270
DIM.	CASE DIAMETER																																																
	63	80	100	160	250																																												
A	65	83	101	161	252																																												
B	33	29	31	32	45																																												
C	13	13	13	13	13																																												
D	86	110	132	196	285																																												
H	3.5	4	5.5	6	6																																												
P	75	95	116	178	270																																												
F <i>TXCxxxXF</i>		<table border="1" style="margin-left: auto; margin-right: auto;"> <thead> <tr> <th rowspan="2">DIM.</th> <th colspan="5">CASE DIAMETER</th> </tr> <tr> <th>63</th> <th>80</th> <th>100</th> <th>160</th> <th>250</th> </tr> </thead> <tbody> <tr> <td>A</td> <td>65</td> <td>83</td> <td>101</td> <td>161</td> <td>252</td> </tr> <tr> <td>B</td> <td>41</td> <td>40</td> <td>51</td> <td>51</td> <td>57</td> </tr> <tr> <td>D</td> <td>86</td> <td>110</td> <td>132</td> <td>196</td> <td>285</td> </tr> <tr> <td>H</td> <td>3.5</td> <td>4</td> <td>5.5</td> <td>6</td> <td>6</td> </tr> <tr> <td>P</td> <td>75</td> <td>95</td> <td>116</td> <td>178</td> <td>270</td> </tr> </tbody> </table>	DIM.	CASE DIAMETER					63	80	100	160	250	A	65	83	101	161	252	B	41	40	51	51	57	D	86	110	132	196	285	H	3.5	4	5.5	6	6	P	75	95	116	178	270						
DIM.	CASE DIAMETER																																																
	63	80	100	160	250																																												
A	65	83	101	161	252																																												
B	41	40	51	51	57																																												
D	86	110	132	196	285																																												
H	3.5	4	5.5	6	6																																												
P	75	95	116	178	270																																												
G <i>TXCxxxXG</i>		<table border="1" style="margin-left: auto; margin-right: auto;"> <thead> <tr> <th rowspan="2">DIM.</th> <th colspan="5">CASE DIAMETER</th> </tr> <tr> <th>63</th> <th>80</th> <th>100</th> <th>160</th> <th>250</th> </tr> </thead> <tbody> <tr> <td>A</td> <td>65</td> <td>83</td> <td>101</td> <td>161</td> <td>252</td> </tr> <tr> <td>B</td> <td>33</td> <td>29</td> <td>31</td> <td>32</td> <td>45</td> </tr> <tr> <td>D</td> <td>86</td> <td>110</td> <td>132</td> <td>196</td> <td>285</td> </tr> <tr> <td>H</td> <td>3.5</td> <td>4</td> <td>5.5</td> <td>6</td> <td>6</td> </tr> <tr> <td>P</td> <td>75</td> <td>95</td> <td>116</td> <td>178</td> <td>270</td> </tr> </tbody> </table>	DIM.	CASE DIAMETER					63	80	100	160	250	A	65	83	101	161	252	B	33	29	31	32	45	D	86	110	132	196	285	H	3.5	4	5.5	6	6	P	75	95	116	178	270						
DIM.	CASE DIAMETER																																																
	63	80	100	160	250																																												
A	65	83	101	161	252																																												
B	33	29	31	32	45																																												
D	86	110	132	196	285																																												
H	3.5	4	5.5	6	6																																												
P	75	95	116	178	270																																												

TYPE H AND I SEE PAGE 13-1

SECUTHERM® CAPILLARY DIAL THERMOMETERS

Type TXC, with stainless steel case according to EN 13190

STANDARD MODEL:

CASE	: bayonet lock, AISI304/1.4301, IP-65
CAPILLARY TUBE	: see page 25 (upto 100 meters)
STEM AND BULB	: AISI321/1.4541, see page 26 - 28
CONNECTION	: AISI304/1.4301, see page 26 -28
WINDOW	: mineral glass 4 mm
DIAL	: aluminium, black figures on white
POINTER	: aluminium, black
RANGES	: from -200 upto +800°C, see page 19 - 20

EXAMPLE:

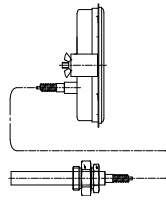

TXC160XH

ADJUSTMENT	: +/- 6 % F.S. with adj. screw at the side
OVERLOAD	: up to 30% F.S. (but max. 800°C)
ACCURACY	: ±1% F.S. / class 1
MOVEMENT	: brass
OPTIONS	: see page 33
CONTACTS	: see page 34 - 45
PT-100	: see page 44
TRANSMITTER	: see page 44

TYPE	MODEL	CASE DIAMETER (Ø in mm)				
		63	80	100	160	250
A 1140		TXC063XA	TXC080XA	TXC100XA	TXC160XA	TXC250XA
B 1142		TXC063XB	TXC080XB	TXC100XB	TXC160XB	TXC250XB
D 1141		TXC063XD	TXC080XD	TXC100XD	TXC160XD	TXC250XD
F 1148		TXC063XF	TXC080XF	TXC100XF	TXC160XF	TXC250XF
G 1145		TXC063XG	TXC080XG	TXC100XG	TXC160XG	TXC250XG
H 1146		TXC063XH	TXC080XH	TXC100XH	TXC160XH	TXC250XH
I -		TXC063XI	TXC080XI	TXC100XI	TXC160XI	TXC250XI
OPTION (see also page 32)		EXTRA COSTS				
Lx	LIQUID FILLED CASE: GLYCERINE (in combination with electrical device: OIL, see page 43)	TXC063Lx	TXC080Lx	TXC100Lx	TXC160Lx	TXC250Lx

CAPILLARY DIAL THERMOMETERS TYPE TXC

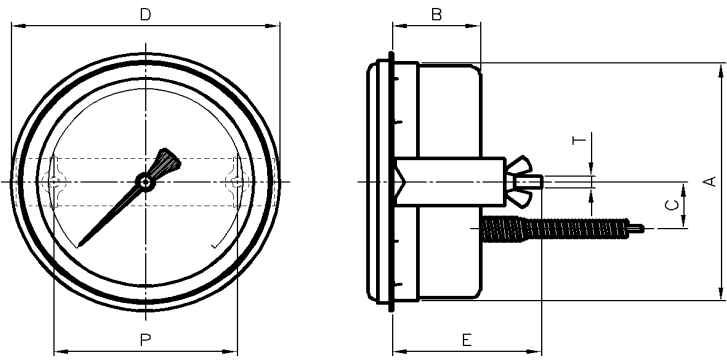
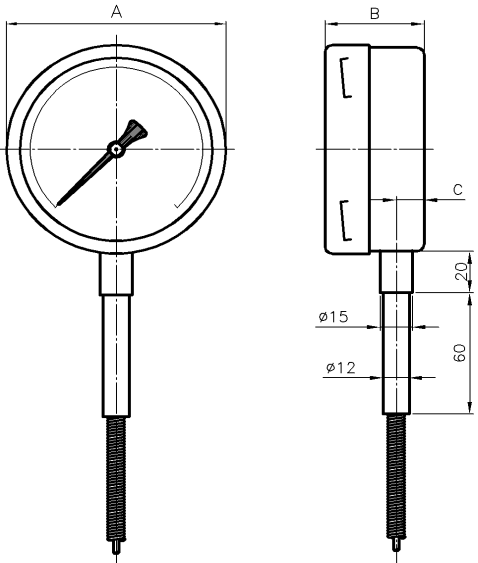
TYPE	DRAWING	DIMENSIONS mm																																																					
H TXCxxxXH		<table border="1"> <thead> <tr> <th rowspan="2">DIM.</th> <th colspan="5">CASE DIAMETER</th> </tr> <tr> <th>63*</th> <th>80</th> <th>100</th> <th>160</th> <th>250+</th> </tr> </thead> <tbody> <tr> <td>A</td> <td>65</td> <td>83</td> <td>101</td> <td>161</td> <td>252</td> </tr> <tr> <td>B</td> <td>30</td> <td>35</td> <td>35</td> <td>35</td> <td>45</td> </tr> <tr> <td>C</td> <td>20**</td> <td>25</td> <td>20</td> <td>20</td> <td>0</td> </tr> <tr> <td>D</td> <td>70</td> <td>95</td> <td>112</td> <td>180</td> <td>270</td> </tr> <tr> <td>E</td> <td>50</td> <td>55</td> <td>60</td> <td>60</td> <td>70</td> </tr> <tr> <td>P</td> <td>33</td> <td>59</td> <td>75</td> <td>139</td> <td>+</td> </tr> <tr> <td>T</td> <td>M5</td> <td>M5</td> <td>M5</td> <td>M5</td> <td>M5</td> </tr> </tbody> </table> <p>* U-clamp vertical mounted ** 20 mm to the left (front view) + with 3 clamps under 120 degr.</p>	DIM.	CASE DIAMETER					63*	80	100	160	250+	A	65	83	101	161	252	B	30	35	35	35	45	C	20**	25	20	20	0	D	70	95	112	180	270	E	50	55	60	60	70	P	33	59	75	139	+	T	M5	M5	M5	M5	M5
		DIM.		CASE DIAMETER																																																			
63*	80		100	160	250+																																																		
A	65	83	101	161	252																																																		
B	30	35	35	35	45																																																		
C	20**	25	20	20	0																																																		
D	70	95	112	180	270																																																		
E	50	55	60	60	70																																																		
P	33	59	75	139	+																																																		
T	M5	M5	M5	M5	M5																																																		
I TXCxxxXI		<table border="1"> <thead> <tr> <th rowspan="2">DIM.</th> <th colspan="5">CASE DIAMETER</th> </tr> <tr> <th>63</th> <th>80</th> <th>100</th> <th>160</th> <th>250</th> </tr> </thead> <tbody> <tr> <td>A</td> <td>65</td> <td>83</td> <td>101</td> <td>161</td> <td>252</td> </tr> <tr> <td>B</td> <td>38</td> <td>37</td> <td>45</td> <td>45</td> <td>55</td> </tr> <tr> <td>C</td> <td>13</td> <td>13</td> <td>13</td> <td>13</td> <td>13</td> </tr> </tbody> </table>	DIM.	CASE DIAMETER					63	80	100	160	250	A	65	83	101	161	252	B	38	37	45	45	55	C	13	13	13	13	13																								
		DIM.		CASE DIAMETER																																																			
63	80		100	160	250																																																		
A	65	83	101	161	252																																																		
B	38	37	45	45	55																																																		
C	13	13	13	13	13																																																		

CAPILLARY DIAL THERMOMETERS TYPE TPC

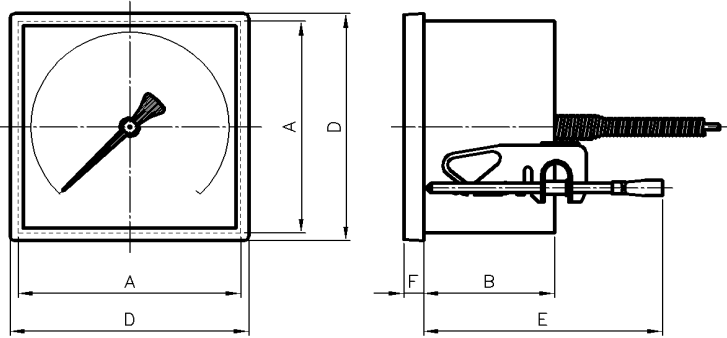
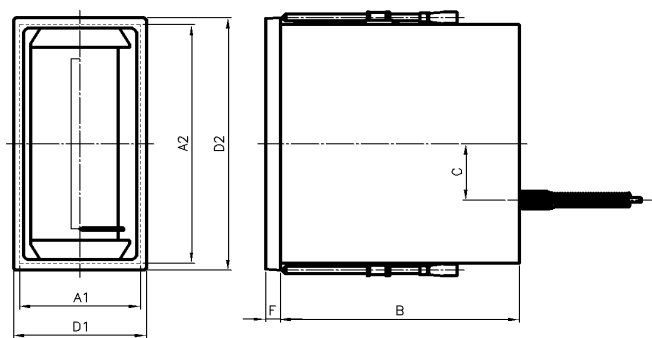
S TPCxxxxxXS		<table border="1"> <thead> <tr> <th rowspan="2">DIM.</th> <th colspan="4">CASE DIAMETER</th> </tr> <tr> <th>72 x 72</th> <th>96 x 96</th> <th>144x 144</th> <th>192x192</th> </tr> </thead> <tbody> <tr> <td>A</td> <td>66</td> <td>90</td> <td>136</td> <td>183</td> </tr> <tr> <td>B</td> <td>53</td> <td>53</td> <td>53</td> <td>89</td> </tr> <tr> <td>D</td> <td>72</td> <td>96</td> <td>144</td> <td>195</td> </tr> <tr> <td>E</td> <td>95</td> <td>95</td> <td>95</td> <td>95</td> </tr> <tr> <td>F</td> <td>8</td> <td>8</td> <td>8</td> <td>8</td> </tr> </tbody> </table>	DIM.	CASE DIAMETER				72 x 72	96 x 96	144x 144	192x192	A	66	90	136	183	B	53	53	53	89	D	72	96	144	195	E	95	95	95	95	F	8	8	8	8
		DIM.		CASE DIAMETER																																
72 x 72	96 x 96		144x 144	192x192																																
A	66	90	136	183																																
B	53	53	53	89																																
D	72	96	144	195																																
E	95	95	95	95																																
F	8	8	8	8																																
V/H TPCxxxxxXV TPCxxxxxXH		<table border="1"> <thead> <tr> <th rowspan="2">DIM.</th> <th colspan="2">CASE DIAMETER</th> </tr> <tr> <th>144x72</th> <th>192x96</th> </tr> </thead> <tbody> <tr> <td>A1</td> <td>66</td> <td>91</td> </tr> <tr> <td>A2</td> <td>136</td> <td>184</td> </tr> <tr> <td>B</td> <td>130</td> <td>155</td> </tr> <tr> <td>C</td> <td>30</td> <td>30</td> </tr> <tr> <td>D1</td> <td>72</td> <td>96</td> </tr> <tr> <td>D2</td> <td>144</td> <td>192</td> </tr> <tr> <td>F</td> <td>8</td> <td>8</td> </tr> </tbody> </table>	DIM.	CASE DIAMETER		144x72	192x96	A1	66	91	A2	136	184	B	130	155	C	30	30	D1	72	96	D2	144	192	F	8	8								
		DIM.		CASE DIAMETER																																
144x72	192x96																																			
A1	66	91																																		
A2	136	184																																		
B	130	155																																		
C	30	30																																		
D1	72	96																																		
D2	144	192																																		
F	8	8																																		

SECUTHERM® CAPILLARY DIAL THERMOMETERS

Type TPC, with glassfibre reinforced black Noryl case

STANDARD MODEL:

CASE : glassfibre reinforced black Noryl, IP45
square or rectangular shaped for panel mounting

CAPILLARY TUBE : see page 25 (upto 100 meter)

STEM AND BULB : AISI321/1.4541, see page 26 - 28

CONNECTION : AISI304/1.4301, see page 26 - 28

WINDOW : plexi-glass PMMA 3 mm

DIAL : aluminium, black figures on white

POINTER : aluminium, black

EXAMPLE:

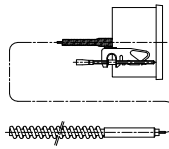

TPC96x96XS

RANGES : from -200 upto +800°C, see page 29 - 30

ADJUSTMENT : +/- 6 % F.S. with adj. screw at the side

OVERLOAD : up to 30% F.S. (but max. 800°C)

ACCURACY : ±1% F.S. / class 1

MOVEMENT : brass

OPTIONS : see page 33

CONTACTS : see page 34 - 45

PT-100 : see page 44

TRANSMITTER : see page 44

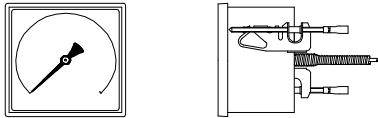
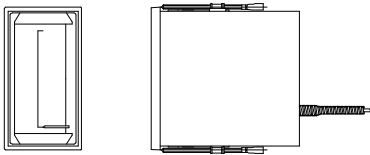
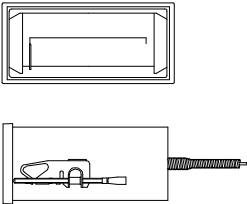
TYPE	SQUARE MODEL	CASE DIMENSIONS (in mm)			
		72x72	96x96	144x144	192x192
S 1201...1204		TPC72x72XS	TPC96x96XS	TPC144x144XS	TPC192x192XS
TYPE	VERTICAL MODEL	72x144		96x192	
V 1211...1212		TPC72x144XV		TPC96x192XV	
TYPE	HORIZONTAL MODEL	144x72		192x96	
H 1211...1212		TPC144x72XH		TPC192x96XH	

NOTE: LIQUID FILLING FOR TYPE TPC IS NOT POSSIBLE (USE E.G. TXC WITH SPECIAL SQUARE FRONTFLANGES : O.D.)

TEMPERATURE RECORDERS

TYPE	DRAWING	DIMENSIONS mm																																			
H <i>RTCxxxXH</i>		<table border="1" style="width: 100%; border-collapse: collapse;"> <thead> <tr style="background-color: #e0f2f1;"> <th rowspan="2">DIM.</th> <th colspan="3">CASE SIZE</th> </tr> <tr style="background-color: #e0f2f1;"> <th>192x192</th> <th>280x280</th> <th>380x380</th> </tr> </thead> <tbody> <tr> <td>A</td> <td>185x185</td> <td>280x280</td> <td>380x380</td> </tr> <tr> <td>B</td> <td>119</td> <td>119</td> <td>125</td> </tr> <tr> <td>C</td> <td>80 down*</td> <td>120</td> <td>172 down*</td> </tr> <tr> <td>D</td> <td>197x197</td> <td>293x293</td> <td>418x418</td> </tr> </tbody> </table> <p>* capillary lower back entry</p>	DIM.	CASE SIZE			192x192	280x280	380x380	A	185x185	280x280	380x380	B	119	119	125	C	80 down*	120	172 down*	D	197x197	293x293	418x418												
DIM.	CASE SIZE																																				
	192x192	280x280	380x380																																		
A	185x185	280x280	380x380																																		
B	119	119	125																																		
C	80 down*	120	172 down*																																		
D	197x197	293x293	418x418																																		
B <i>RTCxxxXB</i>		<table border="1" style="width: 100%; border-collapse: collapse;"> <thead> <tr style="background-color: #e0f2f1;"> <th rowspan="2">DIM.</th> <th colspan="3">CASE SIZE</th> </tr> <tr style="background-color: #e0f2f1;"> <th>192x192</th> <th>280x280</th> <th>380x380</th> </tr> </thead> <tbody> <tr> <td>A</td> <td>185x185</td> <td>280x280</td> <td>380x380</td> </tr> <tr> <td>B</td> <td>122</td> <td>122</td> <td>125</td> </tr> <tr> <td>C</td> <td>80 down*</td> <td>120</td> <td>172 down*</td> </tr> <tr> <td>D</td> <td>189x189</td> <td>283x283</td> <td>418x418</td> </tr> <tr> <td>E</td> <td>252</td> <td>335</td> <td>470</td> </tr> <tr> <td>P1</td> <td>222</td> <td>305</td> <td>440</td> </tr> <tr> <td>P2</td> <td>152</td> <td>247</td> <td>440</td> </tr> </tbody> </table> <p>* capillary lower back entry</p>	DIM.	CASE SIZE			192x192	280x280	380x380	A	185x185	280x280	380x380	B	122	122	125	C	80 down*	120	172 down*	D	189x189	283x283	418x418	E	252	335	470	P1	222	305	440	P2	152	247	440
DIM.	CASE SIZE																																				
	192x192	280x280	380x380																																		
A	185x185	280x280	380x380																																		
B	122	122	125																																		
C	80 down*	120	172 down*																																		
D	189x189	283x283	418x418																																		
E	252	335	470																																		
P1	222	305	440																																		
P2	152	247	440																																		
T <i>RTCxxxXT</i>		<table border="1" style="width: 100%; border-collapse: collapse;"> <thead> <tr style="background-color: #e0f2f1;"> <th rowspan="2">DIM.</th> <th colspan="3">CASE SIZE</th> </tr> <tr style="background-color: #e0f2f1;"> <th>192x192</th> <th>280x280</th> <th>380x380</th> </tr> </thead> <tbody> <tr> <td>A</td> <td>185x185</td> <td>280x280</td> <td>380x380</td> </tr> <tr> <td>B</td> <td>141</td> <td>141</td> <td>125</td> </tr> <tr> <td>C</td> <td>80 down*</td> <td>120</td> <td>172 down*</td> </tr> <tr> <td>D</td> <td>189x189</td> <td>283x283</td> <td>418x418</td> </tr> <tr> <td>E</td> <td>188</td> <td>260</td> <td>280</td> </tr> <tr> <td>F</td> <td>260</td> <td>354</td> <td>465</td> </tr> </tbody> </table> <p>* capillary lower back entry</p>	DIM.	CASE SIZE			192x192	280x280	380x380	A	185x185	280x280	380x380	B	141	141	125	C	80 down*	120	172 down*	D	189x189	283x283	418x418	E	188	260	280	F	260	354	465				
DIM.	CASE SIZE																																				
	192x192	280x280	380x380																																		
A	185x185	280x280	380x380																																		
B	141	141	125																																		
C	80 down*	120	172 down*																																		
D	189x189	283x283	418x418																																		
E	188	260	280																																		
F	260	354	465																																		

SECUTHERM® TEMPERATURE RECORDERS

Type RTC, with capillary

STANDARD MODEL:

CASE	: stainless steel AISI316/1.4401	CHARTS	: 50 pcs, Ø166mm for 192x192mm, Ø223 for 280x280mm Ø300 for 380x380mm
WINDOW	: plexiglass	STEM & BULB	: see page 26 - 28
DIAL	: transparent with black figures	CAPILLARY	: see page 25
PEN OPERATION	: single or double-pen (option), writing with long-life fiber pens on disc	CONNECTION	: see page 26 -28
CLOCKWORK	: mechanical spring wound, 1-, 4-, 12-, 24 hours or 7 day rotation, with start/stop button. Electric clockworks on demand. Switchable clockworks on demand.	MOVEMENT	: brass
		ACCURACY	: ±1%F.S./class 1
		OPTIONS	: double pen writing combination temperature / pressure

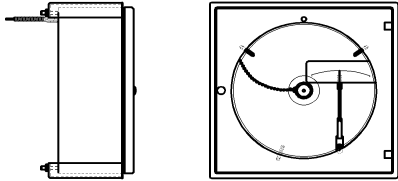
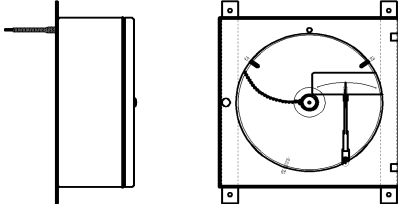
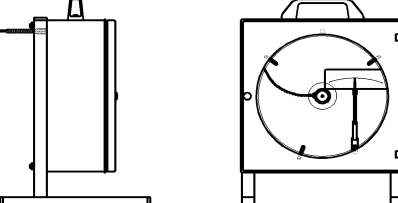
TYPE	SQUARE MODELS	CASE DIMENSIONS (in mm)		
		192x192 mm	280x280 mm	380x380 mm
H PANEL MOUNTING		RTC192x192XH	RTC280x280XH	RTC380x380XH
B SURFACE MOUNTING		RTC192x192XB	RTC280x280XB	RTC380x380XB
T TRANSPORTABLE		RTC192x192XT	RTC280x280XT	RTC380x380XT
OPTIONS (see also page 19)		CASE DIMENSIONS (in mm)		
		192x192 mm	280x280 mm	380x380 mm
RTC-DUPLEX	DOUBLE MEASURING SYSTEM (calculate also 2x capillary and bulb)			
CHARTS	Ø166, Ø223 or Ø300mm PER 100 PCS.			
SPARE PENS	PER 5 PCS, black, red or blue			

CAPILLARY

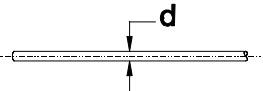
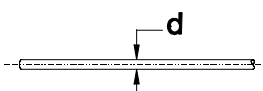
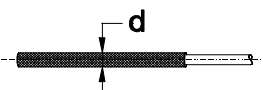
MATERIAL	MODEL	Ø d (mm)	Tmin	Tmax	CAPILLARY LENGTH Lc	
			°C		EXTRA COSTS	
RED COPPER		2,5	-120	+400	per 1000 mm	
STAINLESS STEEL AISI321 / 1.4541		2,5	-260	+800	per 1000 mm	
STAINLESS STEEL AISI321 / 1.4541 + PVC		4	-60	+120	per 1000 mm	

CAPILLARY COVERINGS for above mentioned capillary

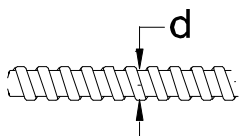
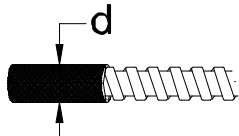
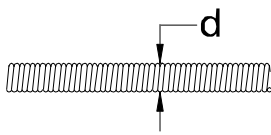
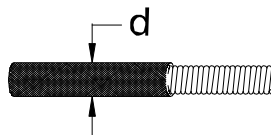
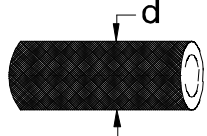
MATERIAL	MODEL	Ø d (mm)	Tmin	Tmax	CAPILLARY LENGTH Lc	
			°C		FIRST 1000 MM	FURTHER PER 1000 MM
FLEXIBLE STAINLESS STEEL AISI304/1.4301		6	-260	+800		
FLEXIBLE STAINLESS STEEL AISI304/1.4301 +PVC		7,5	-60	+120		
FLEXIBLE STAINLESS STEEL AISI316/1.4401		6	-260	+800		
FLEXIBLE STAINLESS STEEL AISI316/1.4401 +PVC		7,5	-60	+120		
PLUMB (Pb)		16	-20	+200		

BULB LENGTH AND DIAMETER FOR TYPE TXC

TYPE	STANDARD MODEL	bulb diameter Ø d	EXTRA COSTS per 100 mm STAINLESS STEEL AISI321/1.4541
A <i>plain stem</i>		9, 10, 12	per 100 mm
		6, 6.35, 8, 11, 12.5, 13, 14	per 100 mm
		7, 15, 16, 17, 18, 20	per 100 mm
FOR SHORTEST SENSITIVE PART "Ls": SEE PAGE 32		FOR OPTIONS ON BULB LENGTH AND DIAMETER: SEE PAGE 27	

CONNECTIONS FOR CAPILLARY MODELS TYPE TXC

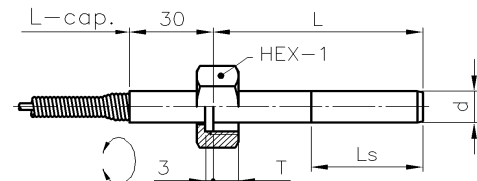
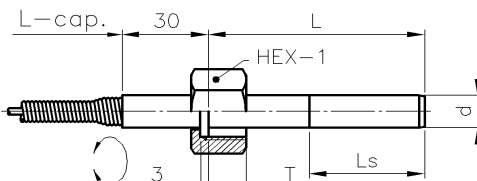
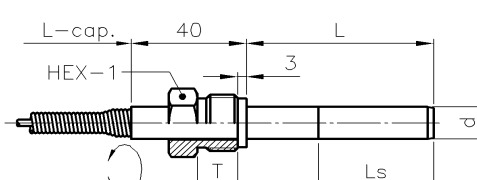
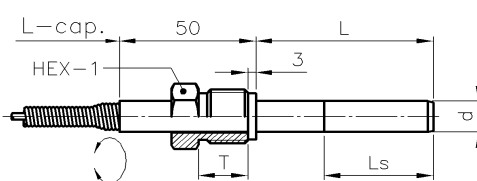
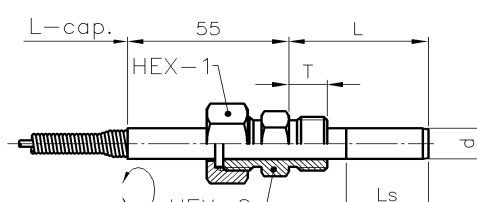
TYPE	MODEL FOR OPTIONS ON CONNECTIONS: SEE PAGE 28	DIMENSIONS				EXTRA COSTS	
		connection	HEX-1	HEX-2	T	d max	STAINLESS STEEL AISI304/1.4301
B <i>coupling nut (standard model)</i>		1/4"BSP	22	-	7	Ø 8	
		3/8"BSP	27	-	9	Ø 11	
		1/2"BSP	27	-	9	Ø 15	
		3/4"BSP	32	-	9	Ø 20	
		1"BSP	41	-	13	Ø 20	
		M18x1.5	27	-	8	Ø 12	
		M20x1.5	27	-	9	Ø 14	
		M24x1.5	32	-	9	Ø 18	
BL <i>coupling nut (long model)</i>		1/2"BSP	27	-	14	Ø 15	
		3/4"BSP	32	-	16	Ø 20	
		1"BSP	41	-	18	Ø 20	
A04 <i>turning nipple (standard model)</i>		1/4"BSP	17	-	12	Ø 8	
		3/8"BSP	22	-	12	Ø 11	
		1/2"BSP	22	-	14	Ø 15	
		3/4"BSP	30	-	16	Ø 20	
		1"BSP	36	-	18	Ø 20	
		M18x1.5	22	-	12	Ø 12	
		M24x1.5	27	-	14	Ø 18	
AL04 <i>turning nipple (long model)</i>		1/2"BSP	22	-	20	Ø 15	
		3/4"BSP	30	-	20	Ø 20	
		1"BSP	36	-	25	Ø 20	
B 01 <i>coupling nut + double nipple</i>	 <p style="text-align: center; font-size: small;">THREAD BETWEEN HEX-1 and HEX-2: 1/2"BSP</p>	1/4"BSP	27	22	12	Ø 8	
		3/8"BSP	27	22	12	Ø 11	
		1/2"BSP	27	22	14	Ø 15	
		3/4"BSP	27	27	16	Ø 20	
		1"BSP	27	36	18	Ø 20	
		1/4"NPT	27	22	14	Ø 8	
		1/2"NPT	27	22	20	Ø 15	
		3/4"NPT	27	27	20	Ø 20	
		1"NPT	27	36	25	Ø 20	
		M18x1.5	27	22	12	Ø 12	
		M24x1.5	27	27	14	Ø 18	

CONNECTIONS FOR CAPILLARY MODELS TYPE TXC

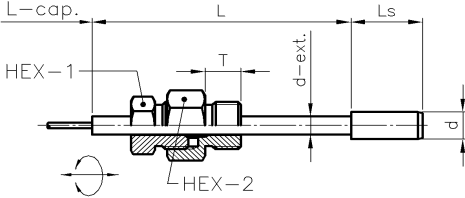
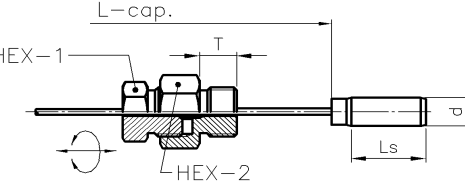
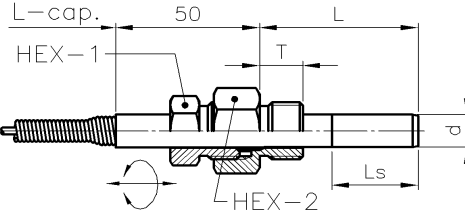
TYPE	MODEL FOR OPTIONS ON CONNECTIONS: SEE PAGE 28	DIMENSIONS				EXTRA COSTS	
		connection	HEX-1	HEX-2	T	d max	STAINLESS STEEL AISI304/1.4301
CS 1 <i>adjustable connection, sliding on extension tube</i>	 <p>THREAD BETWEEN HEX-1 and HEX-2: 1/2"BSP</p>	1/4"BSP	22	27	12	Ø 11	
		3/8"BSP	22	27	12	Ø 14	
		1/2"BSP	22	27	14	Ø 18	
		3/4"BSP	22	32	16	Ø 23	
		1"BSP	22	36	18	Ø 30	
		1/4"NPT	22	27	14	Ø 13	
		1/2"NPT	22	27	20	Ø 20	
		3/4"NPT	22	27	20	Ø 25	
		1"NPT	22	36	25	Ø 32	
		M18x1.5	22	27	12	Ø 16	
		M20x1.5	22	27	14	Ø 18	
		M24x1.5	22	27	14	Ø 22	
		CS 2 <i>adjustable connection, sliding on capillary</i>	 <p>THREAD BETWEEN HEX-1 and HEX-2: 1/2"BSP</p>	1/4"BSP	22	27	12
3/8"BSP	22			27	12	Ø 14	
1/2"BSP	22			27	14	Ø 18	
3/4"BSP	22			32	16	Ø 23	
1"BSP	22			36	18	Ø 30	
1/4"NPT	22			27	14	Ø 13	
1/2"NPT	22			27	20	Ø 20	
3/4"NPT	22			27	20	Ø 25	
1"NPT	22			36	25	Ø 32	
M18x1.5	22			27	12	Ø 16	
M20x1.5	22			27	14	Ø 18	
M24x1.5	22			27	14	Ø 22	
CS 3 <i>adjustable connection, sliding on stem</i>	 <p>THREAD BETWEEN HEX-1 and HEX-2: 1/2"BSP</p>			1/4"BSP	22	27	12
		3/8"BSP	22	27	12	Ø 11	
		1/2"BSP	22	27	14	Ø 15	
		3/4"BSP	22	32	16	Ø 20	
		1"BSP	22	36	18	Ø 20	
		1/4"NPT	22	27	14	Ø 8	
		1/2"NPT	22	27	20	Ø 15	
		3/4"NPT	22	27	20	Ø 20	
		1"NPT	22	36	25	Ø 20	
		M18x1.5	22	27	12	Ø 12	
		M20x1.5	22	27	14	Ø 14	
		M24x1.5	22	27	14	Ø 18	

CONNECTIONS FOR CAPILLARY MODELS TYPE TXC

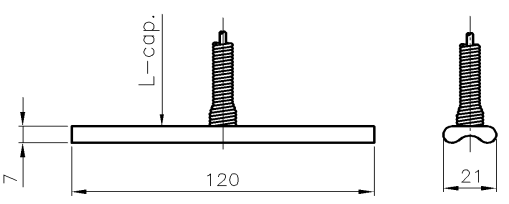
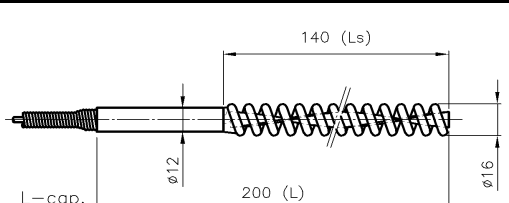
TYPE	MODEL	DIMENSIONS			EXTRA COSTS
					STAINLESS STEEL
		L	D-1	D-2	AISI321/1.4541
S <i>surface bulb</i>	 <p style="font-size: small; text-align: right;">for L longer than 100 see page 26</p>	-	-	-	
HA <i>helical air bulb</i>	 <p style="font-size: small; text-align: right;">for L longer than 200 see page 26</p>	-	-	-	

SANITARY CONNECTIONS FOR CAPILLARY MODELS TYPE TXC

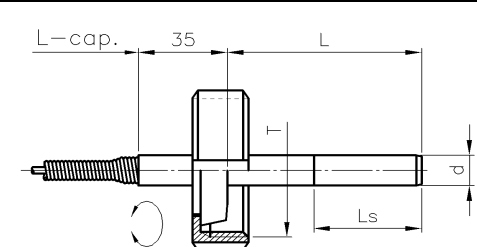
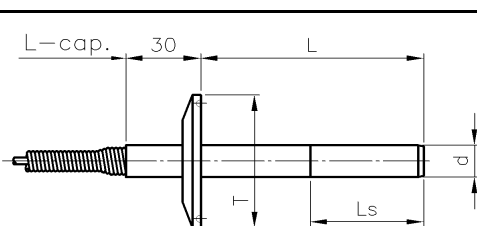
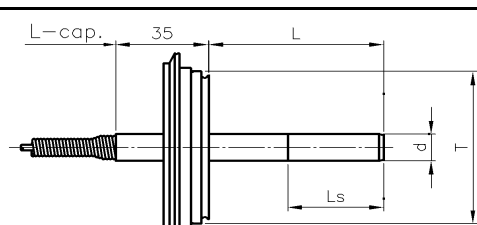
TYPE	MODEL WITH POLISHED BULB	DIMENSIONS		EXTRA COSTS
				STAINLESS STEEL
		connection	T	AISI316/1.4401
CM <i>acc. to DIN 11851</i>	 <p style="font-size: small; text-align: center;">(also available in SMS, RJT, IDF etc.)</p>	1" - NW25	rd 52 x 1/6	
		1 1/2" - NW40	rd 65 x 1/6	
		2" - NW50	rd 78 x 1/6	
		3" - NW75	rd 104 x 1/6	
TC <i>TRI CLAMP acc. to ISO 2852</i>		1" - NW25	Ø 50.5	
		1 1/2" - NW40	Ø 50.5	
		2" - NW50	Ø 64	
TV <i>Varivent® In-Line</i>		NW 10-15	Ø 31	ON DEMAND
		NW 25-32	Ø 50	
		NW 40-50	Ø 68	

OPTIONS FOR BULB AND STEM

OPTION	EXTRA COSTS	
	PER 100 MM	
BULB AND STEM AISI316/1.4401	for diameter 6, 8, 9, 10, 12, 13, 14, 15, 16, 18	
BULB AND STEM POLISHED (MECHANICAL)	for all diameters	
BULB AND STEM PTFE® LINING (max.250° C)	first 100 mm: per 100 mm extra:	
BULB AND STEM HALAR® COATED (max.120° C)		

TEMPERATURE RANGES for all types:

TEMPERATURE RANGES			EXTRA COSTS											
(in °C)	SCALE DIVISION		CASE DIMENSIONS (in mm)											
	cl. 1	option cl. 0.6	Ø 63	Ø 80	Ø 100	Ø 160	Ø 260	72x72	96x96	144x144	192x192	288x288	72x144 144x72	192x96 96x192
-200 ...+50	5	2												
-120 ...+40	2	1												
-110 ...+50	5	1												
-100 ...+100	5	1												
-100 ...+50	5	1												
-80 ...+40	2	1												
-60 ...+40	2	0.5												
-60 ...+60	2	1												
-50 ...+50	2	0.5												
-50 ...+100	5	1												
-40 ...+20	1	0.5												
-40 ...+40	1	0.5												
-40 ...+60	2	0.5												
-40 ...+80	2	1												
-40 ...+110	5	1												
-40 ...+120	2	0.5												
-40 ...+160	5	1												
-30 ...+30	1	0.5												
-30 ...+50	1	0.5												
-30 ...+70	2	0.5												
-30 ...+170	5	1												
-20 ...+40	1	0.5												
-20 ...+60	1	0.5												
-20 ...+80	2	0.5												
-20 ...+100	2	1												
-20 ...+120	2	1												
-20 ...+180	5	1												
-15 ...+45	1	0.5												
-10 ...+15	0.5	0.2							x					
-10 ...+30	1	0.2							x					
-10 ...+50	1	0.5												
-10 ...+110	2	1												
-10 ...+150	5	1												
0 ...+25	0.5	0.2							x					
0 ...+40	1	0.2							x					
0 ...+60	1	0.5												
0 ...+80	1	0.5												
0 ...+100	2	0.5												
0 ...+120	2	1												
0 ...+160	5	1												
0 ...+200	5	1							8,00					
0 ...+250	5	2							8,00					
0 ...+300	5	2												
0 ...+400	10	2												
0 ...+500	10	5							14,50					
0 ...+600	10	5												
0 ...+700	10	5												
0 ...+800	10	5												

x NOT AVAILABLE
 • STANDARD
 FOR OPTIONS ON TEMPERATURE RANGES: SEE PAGE 30

OTHER RANGES ON DEMAND

TEMPERATURE RANGES for TXR-DIESEL:

TEMPERATURE RANGES		EXTRA COSTS		
(in °C)	SCALE DIVISION	CASE DIMENSIONS (in mm)		
	cl. 1	Ø 63	Ø 80	Ø 100
0 ...+600	10		•	
0 ...+650	10		•	
0 ...+700	10			
0 ...+750	10			
0 ...+800	10			
+50 ...+600	10			
+50 ...+650	10		•	
+50 ...+700	10			
+100 ...+600	10			
+100 ...+650	10			
+100 ...+700	10			

OPTIONS ON TEMPERATURE RANGES (excl. temp. recorder)

OPTIONS	EXTRA COSTS										
	CASE DIMENSIONS (in mm)										
	Ø 63	Ø 80	Ø 100	Ø 160	Ø 250	72x72	96x96	144x144	192x192	72x144 144x72	192x96 96x192
RANGE IN °F or °K											
Standard ranges											
Non-standard ranges											
DUAL SCALE IN °C/°F											
Standard ranges											
Non-standard ranges											
OTHER OPTIONS											
Non-standard scale division											
ACCURACY											
±1% F.S. / class 1	•	•	•	•	•	•	•	•	•	•	•
±0.6 / 0.5% F.S. (class 0.6 or 0.5)	x	x				x	x				
Mirrorscale (for anti-parallax)	x	x	x			x	x	x	x	x	x

x

NOT AVAILABLE

•

STANDARD

MARKING FOR TEMPERATURE GAUGES

OPTION	EXTRA PRICE
TAG number on dial	
TAG number on AISI304/1.4301 TAG plate 55x25 mm	
Lettering on dial	
Red mark on dial	

CERTIFICATES FOR TEMPERATURE GAUGES

TYPE OF CERTIFICATE	EXTRA PRICE
Certificate of Conformity acc. to EN 10204 2.2.	
Calibration certificate (Traceable to N.K.O.)	
Material certificate wetted parts acc. to EN 10204 3.1.B	

CONVERSION OF DEGREES CELCIUS IN FAHRENHEIT AND REVERSE

READ THE VALUE IN EITHER CELCIUS OR FAHRENHEIT IN THE COLUMN MARKED WITH -X-. READ THE CORRESPONDING VALUE IN CELCIUS OR FAHRENHEIT IN THE COLUMN MARKED WITH °C OR °F. GENERAL: °CELCIUS =5/9x(°FAHRENHEIT - 32)

°C	-X-	°F	°C	-X-	°F	°C	-X-	°F	°C	-X-	°F	°C	-X-	°F
-73,3	-100	-148,0	-1,7	29	84,2	19,4	67	152,6	65,6	150	302,0	276,7	530	986,0
-62,2	-80	-112,0	-1,1	30	86,0	20,0	68	154,4	71,1	160	320,0	282,2	540	1004,0
-56,7	-70	-94,0	-0,6	31	87,8	20,6	69	156,2	76,7	170	338,0	287,8	550	1022,0
-51,1	-60	-76,0	0,0	32	89,6	21,1	70	158,0	82,2	180	356,0	293,3	560	1040,0
-45,6	-50	-58,0	0,6	33	91,4	21,7	71	159,8	87,8	190	374,0	298,9	570	1058,0
-40,0	-40	-40,0	1,1	34	93,2	22,2	72	161,6	93,3	200	392,0	304,4	580	1076,0
-34,4	-30	-22,0	1,7	35	95,0	22,8	73	163,4	98,9	210	410,0	310,0	590	1094,0
-28,9	-20	-4,0	2,2	36	96,8	23,3	74	165,2	104,4	220	428,0	315,6	600	1112,0
-23,3	-10	14,0	2,8	37	98,6	23,9	75	167,0	110,0	230	446,0	326,7	620	1148,0
-17,8	0	32,0	3,3	38	100,4	24,4	76	168,8	115,6	240	464,0	337,8	640	1184,0
-17,2	1	33,8	3,9	39	102,2	25,0	77	170,6	121,1	250	482,0	348,9	660	1220,0
-16,7	2	35,6	4,4	40	104,0	25,6	78	172,4	126,7	260	500,0	360,0	680	1256,0
-16,1	3	37,4	5,0	41	105,8	26,1	79	174,2	132,2	270	518,0	371,1	700	1292,0
-15,6	4	39,2	5,6	42	107,6	26,7	80	176,0	137,8	280	536,0	382,2	720	1328,0
-15,0	5	41,0	6,1	43	109,4	27,2	81	177,8	143,3	290	554,0	393,3	740	1364,0
-14,4	6	42,8	6,7	44	111,2	27,8	82	179,6	148,9	300	572,0	404,4	760	1400,0
-13,9	7	44,6	7,2	45	113,0	28,3	83	181,4	154,4	310	590,0	415,6	780	1436,0
-13,3	8	46,4	7,8	46	114,8	28,9	84	183,2	160,0	320	608,0	426,7	800	1472,0
-12,8	9	48,2	8,3	47	116,6	29,4	85	185,0	165,6	330	626,0	437,8	820	1508,0
-12,2	10	50,0	8,9	48	118,4	30,0	86	186,8	171,1	340	644,0	448,9	840	1544,0
-11,7	11	51,8	9,4	49	120,2	30,6	87	188,6	176,7	350	662,0	460,0	860	1580,0
-11,1	12	53,6	10,0	50	122,0	31,1	88	190,4	182,2	360	680,0	471,1	880	1616,0
-10,6	13	55,4	10,6	51	123,8	31,7	89	192,2	187,8	370	698,0	482,2	900	1652,0
-10,0	14	57,2	11,1	52	125,6	32,2	90	194,0	193,3	380	716,0	493,3	920	1688,0
-9,4	15	59,0	11,7	53	127,4	32,8	91	195,8	198,9	390	734,0	504,4	940	1724,0
-8,9	16	60,8	12,2	54	129,2	33,3	92	197,6	204,4	400	752,0	515,6	960	1760,0
-8,3	17	62,6	12,8	55	131,0	33,9	93	199,4	210,0	410	770,0	526,7	980	1796,0
-7,8	18	64,4	13,3	56	132,8	34,4	94	201,2	215,6	420	788,0	537,8	1000	1832,0
-7,2	19	66,2	13,9	57	134,6	35,0	95	203,0	221,1	430	806,0	548,9	1100	2012,0
-6,7	20	68,0	14,4	58	136,4	35,6	96	204,8	226,7	440	824,0	560,0	1200	2192,0
-6,1	21	69,8	15,0	59	138,2	36,1	97	206,6	232,2	450	842,0	571,1	1300	2372,0
-5,6	22	71,6	15,6	60	140,0	36,7	98	208,4	237,8	460	860,0	582,2	1400	2552,0
-5,0	23	73,4	16,1	61	141,8	37,2	99	210,2	243,3	470	878,0	593,3	1500	2732,0
-4,4	24	75,2	16,7	62	143,6	37,8	100	212,0	248,9	480	896,0	604,4	1600	2912,0
-3,9	25	77,0	17,2	63	145,4	38,3	110	230,0	254,4	490	914,0	615,6	1700	3092,0
-3,3	26	78,8	17,8	64	147,2	38,9	120	248,0	260,0	500	932,0	626,7	1800	3272,0
-2,8	27	80,6	18,3	65	149,0	39,4	130	266,0	265,6	510	950,0	637,8	1900	3452,0
-2,2	28	82,4	18,9	66	150,8	40,0	140	284,0	271,1	520	968,0	648,9	2000	3632,0

SHORTEST SENSITIVE LENGTH FOR ALL TYPES THERMOMETERS

SHORTEST SENSITIVE LENGTH OF THERMOMETERS WITHOUT CONTACT

DIAMETER AND LENGTH OF SENSITIVE PART mm (Ls)														bulb	CAPILLARY LENGTH mm						
6	6.35	7	8	9	10	11	12	12.5/13	14	15	16	18	20		0	<1000	<2000	<5000	<10000	<20000	< 30000
70	50	50	35	30	25	20	18	17	15	14	13	13	12	1/8	80	80	80	100	120	n.a.	n.a.
120	96	80	60	45	35	30	25	25	20	20	17	16	15	1/4	60	60	60	80	80	100	120
190	155	125	90	60	55	45	35	35	30	25	25	20	20	1/2	60	60	60	80	80	80	100
--	--	190	135	100	80	65	55	50	40	35	30	30	26	3/4	60	60	60	60	80	80	100
--	--	--	170	130	100	80	65	60	50	45	40	35	31	1,0	60	60	60	60	60	80	100
--	--	--	--	190	150	120	95	90	70	60	55	50	43	1.5	60	60	60	60	60	60	60

Others on demand

SHORTEST SENSITIVE LENGTH OF THERMOMETERS WITH CONTACT

DIAMETER AND LENGTH OF SENSITIVE PART mm (Ls)														bulb	CAPILLARY LENGTH mm						
6	6.35	7	8	9	10	11	12	12.5/13	14	15	16	18	20		0	<1000	<2000	<5000	<10000	<20000	< 30000
70	50	50	35	30	25	20	18	17	15	14	13	13	12	1/8	120	160	160	160	160	160	160
120	96	80	60	45	35	30	25	25	20	20	17	16	15	1/4	60	80	80	80	80	80	100
190	155	125	90	60	55	45	35	35	30	25	25	20	20	1/2	60	80	80	80	80	80	100
--	--	190	135	100	80	65	55	50	40	35	30	30	26	3/4	60	60	60	60	80	80	80
--	--	--	170	130	100	80	65	60	50	45	40	35	31	1,0	60	60	60	60	60	80	80
--	--	--	--	190	150	120	95	90	70	60	55	50	43	1.5	60	60	60	60	60	60	80

Others on demand

EXAMPLE: **Bulb diameter** **10 mm**
 Capillary length **5000 mm**
 Range **-20/+40C (= 60C span)**

Look at the table: "SHORTEST SENSITIVE LENGTH OF THERMOMETERS WITHOUT CONTACT"

Start at <5000 mm capillary (right side of the table).

Go down till 60C span

Go left. The minimum bulb is 3/4.

Go more left to the diameter and length side.

Stop at the 10 (mm diameter) culom.

The minimum sensitive length is 80 mm.

If this is too long choose a larger diameter, larger range or a shorter capillary length. The minimum active length will be shorter then.

SHORTEST SENSITIVE LENGTH OF THERMOMETERS WITHOUT CONTACT

DIAMETER AND LENGTH OF SENSITIVE PART mm (Ls)														bulb	CAPILLARY LENGTH mm						
6	6.35	7	8	9	10	11	12	12.5/13	14	15	16	18	20		GEEN	<1000	<2000	<5000	<10000	<20000	< 30000
														1/8							
														1/4							
														1/2							
					80									3/4			60				
														1,0							
														1.5							

OPTIONS FOR SECUTHERM® THERMOMETERS

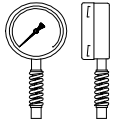
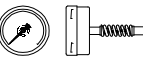
OPTION		CASE DIAMETER (Ø in mm)				
		63	80	100	160	250
SILICONE OIL FILLING	AGAINST HEAVY VIBRATIONS					
CASE MATERIAL AISI316/1.4401 <small>(i.o. AISI304/1.4301)</small>	CASE + BAYONETRING FRONT -OR BACKFLANGE	N.A.	N.A.			N.A. N.A.
ANTI-VIBRATIONSPRING <small>for model: TXR, Type A and E SEE ALSO TXR-DIESEL</small> +AVS	<div style="display: flex; flex-direction: column; align-items: center;"> <div style="display: flex; align-items: center; margin-bottom: 10px;"> A  </div> <div style="display: flex; align-items: center;"> E  </div> </div>	+AVS	+AVS	+AVS	+AVS	+AVS
PLEXIGLASS	PMMA					
"SECURIT" GLASS	SAFETY GLASS					
DRAG POINTER	RESETABLE WITH KEY					
DRAG POINTER IN COMBINATION WITH CONTACT	RESETABLE WITH KEY ONLY FOR "HZ" CONTACTS	N.A.	N.A.			N.A.
OVERLOAD RESISTANCE EXECUTION	OVERLOAD POSSIBLE UPTO 100% DEPENDING ON RANGE MAXIMUM +800°C					
STAINLESS STEEL MOVEMENT	AISI304/1.4301					
MICROMETER POINTER	ADJUSTABLE POINTER					

BUILT-IN MICROSWITCH TYPE Q

TYPE Q Hz (low hysteresis)

example: TXC100XB + Q - 33 Hz



Class 1 and 5 Amp!!

STANDARD MODEL

INSTRUMENT	: class 1
MINIMAL RANGE	: 60 °C
CONNECTOR	: cable junction box, SEE BELOW
HYSTERESIS	: max. 1% up and down
SETPOINT(S)	: from outside
WINDOW	: PMMA - plexiglass
POINTER	: micro adjustable
CONTACT POINTER(S)	: first red, (second yellow)

ELECTRICAL SWITCH CAPACITY

125 Vac	: 5A (ind. load 0.1A)
250 Vac	: 3A (ind. load 0.1A)
DC 30 V	: 5A (ind. load 0.1A)
DC 125 V	: 0.4A
DC 250 V	: 0.2A

CONTACT TYPE	SWITCH FUNCTION	CABLE JUNCTION BOX	CASE DIMENSIONS			
			100	160	96x96	144x144
Q - 3 Hz SPDT		 Hirschmann				
Q - 33 Hz DPDT		 Wiebrock				
OPTION			EXTRA COSTS			
SETPOINT	FIXED SETPOINT (without setpoint adjustment)		0	0	0	0

BUILT-IN LOW-ACTION CONTACT TYPE S

TYPE S Hz

INSTRUMENT	: class 1
MINIMAL RANGE	: 60 °C
CONNECTOR	: cable junction box, SEE BELOW
HYSTERESIS	: max. 1% up and down
SETPOINT(S)	: from outside with key
WINDOW	: PMMA - plexiglass
POINTER	: black (adjustable see page 24)
CONTACT POINTER(S)	: red

example:

TXR100XA

+ S-12 Hz



ELECTRICAL SWITCH CAPACITY

AC	: 18 VA (max. 250V)
DC	: 10 W (max. 250V)

CONTACT TYPE	SWITCH FUNCTION	CABLE JUNCTION BOX	CASE DIMENSIONS				
			100	160	96x96	144x144	72x144
S-1 Hz		<p>Hirschmann</p>					
S-2 Hz							
S-3 Hz							
S-11 Hz							
S-12 Hz							
S-21 Hz							
S-22 Hz							
S-xx Hz +GS	<p>example: S-21 Hz GS</p>	<p>Wiebrock</p>					
S-33 Hz							N.A.
S-33 Hz+GS							N.A.
S-xxx Hz	function to be specified at order						N.A.
S-xxxx Hz	function to be specified at order			O.D.	O.D.	O.D.	O.D.
OPTION			EXTRA COSTS				
Lx	LIQUID FILLED CASE (ONDINA)				N.A.	N.A.	N.A.

BUILT-IN LOW-ACTION CONTACT TYPE M

TYPE M Hz

INSTRUMENT	: class 1
MINIMAL RANGE	: 60 °C
CONNECTOR	: cable junction box, SEE BELOW
HYSTERESIS	: max. 1% up and down
SETPOINT(S)	: from outside with key
WINDOW	: PMMA - plexiglass
POINTER	: black (adjustable see page 24)
CONTACT POINTER(S)	: red

example:

TXR100XA
+ M-12 Hz



ELECTRICAL SWITCH CAPACITY

AC	: 50 VA (max. 250V)
DC	: 30 W (max. 250V)

CONTACT TYPE	SWITCH FUNCTION	CABLE JUNCTION BOX	CASE DIMENSIONS				
			100	160	96x96	144x144	72x144
M-1 Hz		<p>Hirschmann</p>					
M-2 Hz							
M-3 Hz							
M-11 Hz							
M-12 Hz							
M-21 Hz							
M-22 Hz							
M-xx Hz +GS	<p>example: S-21 Hz GS</p>	<p>Wiebrock</p>					
M-33 Hz							N.A.
M-33 Hz+GS							N.A.
M-xxx Hz	functions to be specified at order					N.A.	
M-xxxx Hz	functions to be specified at order		O.D.	O.D.	O.D.	O.D.	N.A.
OPTION			EXTRA COSTS				
Lx	LIQUID FILLED CASE (ONDINA)				N.A.	N.A.	N.A.

BUILT-IN INDUCTIVE CONTACT TYPE I

TYPE I Hz

INSTRUMENT	: class 1
MINIMAL RANGE	: 60 °C
CONNECTOR	: cable junction box, SEE BELOW
HYSTERESIS	: max. 1% up and down
SETPOINT(S)	: from outside with key
WINDOW	: PMMA - plexiglass
POINTER	: black (adjustable see page 24)
CONTACT POINTER(S)	: red

ELECTRICAL SWITCH CAPACITY

Nominal voltage	: 8V (Ri=1 Kohm)
Explosion proof	: EEx ib II C T6
Regulations	: EN 60947-5-2

example:

TXR100XA

+ I-12 Hz



CONTACT TYPE	SWITCH FUNCTION OPERATING CURRENT	CABLE JUNCTION BOX	CASE DIMENSIONS						
			100	160	96x96	144x144	72x144		
I-1 Hz <i>Si 2-K08-Y1 (Turck)</i>		<p>Hirschmann</p>							
I-2 Hz <i>Si 2-K08-Y1 (Turck)</i>									
I-x Hz+2SN <i>SJ 2 SN (Pepperl+Fuchs)</i>				N.A.		N.A.			
I-x Hz+3.5SN <i>SJ 3.5 SN (Pepperl+Fuchs)</i>				N.A.		N.A.	N.A.		
I-11 Hz <i>Si 2-K08-Y1 (Turck)</i>									
I-12 Hz <i>Si 2-K08-Y1 (Turck)</i>									
I-21 Hz <i>Si 2-K08-Y1 (Turck)</i>									
I-22 Hz <i>Si 2-K08-Y1 (Turck)</i>									
I-xx Hz+2SN <i>SJ 2 SN (Pepperl+Fuchs)</i>	function to be specified at order				N.A.		N.A.		
I-xx Hz+3.5SN <i>SJ 3.5 SN (Pepperl+Fuchs)</i>	function to be specified at order		<p>Wiebrock</p>			N.A.		N.A.	
I-xxx Hz <i>Si 2-K08-Y1 (Turck)</i>	function to be specified at order				O.D.		O.D.		N.A.
I-xxxx Hz <i>Si 2-K08-Y1 (Turck)</i>	function to be specified at order				O.D.		O.D.		N.A.
OPTION									
Lx	LIQUID FILLED CASE (ONDINA)				N.A.		N.A.		N.A.

BUILT-IN ELECTRONIC CONTACT TYPE E

TYPE E Hz

INSTRUMENT	: class 1
MINIMAL RANGE	: 60 °C
CONNECTOR	: cable junction box, SEE BELOW
HYSTERESIS	: max. 1% up and down
SETPOINT(S)	: from outside with key
WINDOW	: PMMA - plexiglass
POINTER	: black (adjustable see page 24)
CONTACT POINTER(S)	: red

example:

TXR100XA
+ E-12 Hz



ELECTRICAL SWITCH CAPACITY

Nominal voltage	: 10...30 V dc
Proximity sensor	: Si-K08-AP7 (Turck)
Output	: 3-wire, PNP
Regulations	: EN 60947-5-2

CONTACT TYPE	SWITCH FUNCTION	CABLE JUNCTION BOX	CASE DIMENSIONS				
			100	160	96x96	144x144	72x144
E-1 Hz		 Hirschmann					
E-2 Hz							
E-11 Hz							
E-12 Hz							
E-21 Hz							
E-22 Hz							
E-xxx Hz	function to be specified at order	 M20x1.5 Wiebrock	O.D.	O.D.	O.D.	O.D.	N.A.
E-xxxx Hz	function to be specified at order		O.D.	O.D.	O.D.	O.D.	N.A.
OPTION			EXTRA COSTS				
Lx	LIQUID FILLED CASE (ONDINA)				N.A.	N.A.	N.A.

THERMOMETERS TYPE TXR WITH CONTACT

TYPE	DRAWING	DIMENSIONS mm																										
<p>A</p> <p><i>TXRxxxXA</i></p> <p>Hirschman cable junction box</p>		<table border="1"> <thead> <tr> <th rowspan="2">DIM.</th> <th colspan="2">CASE DIAMETER</th> </tr> <tr> <th>100</th> <th>160</th> </tr> </thead> <tbody> <tr> <td>A</td> <td>101</td> <td>161</td> </tr> <tr> <td>B</td> <td>104</td> <td>108</td> </tr> <tr> <td>K</td> <td>92</td> <td>122</td> </tr> </tbody> </table>	DIM.	CASE DIAMETER		100	160	A	101	161	B	104	108	K	92	122												
DIM.	CASE DIAMETER																											
	100	160																										
A	101	161																										
B	104	108																										
K	92	122																										
<p>E</p> <p><i>TXRxxxXE</i></p> <p>Hirschman cable junction box</p>		<table border="1"> <thead> <tr> <th rowspan="2">DIM.</th> <th colspan="2">CASE DIAMETER</th> </tr> <tr> <th>100</th> <th>160</th> </tr> </thead> <tbody> <tr> <td>A</td> <td>101</td> <td>161</td> </tr> <tr> <td>B</td> <td>104</td> <td>108</td> </tr> <tr> <td>K</td> <td>92</td> <td>122</td> </tr> </tbody> </table>	DIM.	CASE DIAMETER		100	160	A	101	161	B	104	108	K	92	122												
DIM.	CASE DIAMETER																											
	100	160																										
A	101	161																										
B	104	108																										
K	92	122																										
<p>T</p> <p><i>TXRxxxXT</i></p> <p>Hirschman cable junction box</p>		<table border="1"> <thead> <tr> <th rowspan="2">DIM.</th> <th colspan="2">CASE DIAMETER</th> </tr> <tr> <th>100</th> <th>160</th> </tr> </thead> <tbody> <tr> <td>A</td> <td>101</td> <td>161</td> </tr> <tr> <td>B</td> <td>104</td> <td>108</td> </tr> <tr> <td>K</td> <td>92</td> <td>122</td> </tr> </tbody> </table>	DIM.	CASE DIAMETER		100	160	A	101	161	B	104	108	K	92	122												
DIM.	CASE DIAMETER																											
	100	160																										
A	101	161																										
B	104	108																										
K	92	122																										
<p>F</p> <p><i>TXRxxxXF</i></p> <p>Hirschman cable junction box</p>		<table border="1"> <thead> <tr> <th rowspan="2">DIM.</th> <th colspan="2">CASE DIAMETER</th> </tr> <tr> <th>100</th> <th>160</th> </tr> </thead> <tbody> <tr> <td>A</td> <td>101</td> <td>161</td> </tr> <tr> <td>B</td> <td>110</td> <td>114</td> </tr> <tr> <td>D</td> <td>132</td> <td>196</td> </tr> <tr> <td>F</td> <td>5</td> <td>5</td> </tr> <tr> <td>H</td> <td>5.5</td> <td>6</td> </tr> <tr> <td>P</td> <td>116</td> <td>178</td> </tr> <tr> <td>K</td> <td>92</td> <td>122</td> </tr> </tbody> </table>	DIM.	CASE DIAMETER		100	160	A	101	161	B	110	114	D	132	196	F	5	5	H	5.5	6	P	116	178	K	92	122
DIM.	CASE DIAMETER																											
	100	160																										
A	101	161																										
B	110	114																										
D	132	196																										
F	5	5																										
H	5.5	6																										
P	116	178																										
K	92	122																										

THERMOMETERS TYPE TXR WITH CONTACT

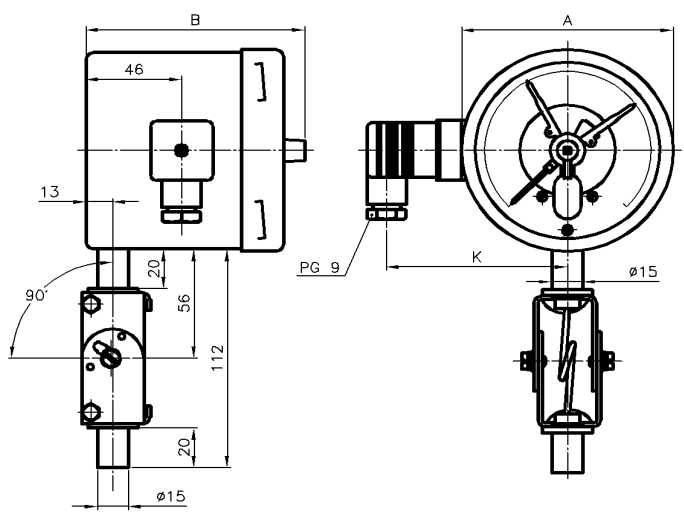
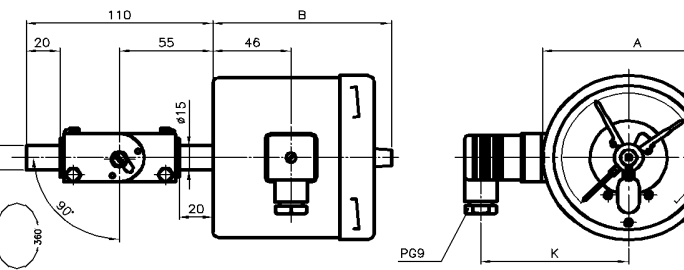
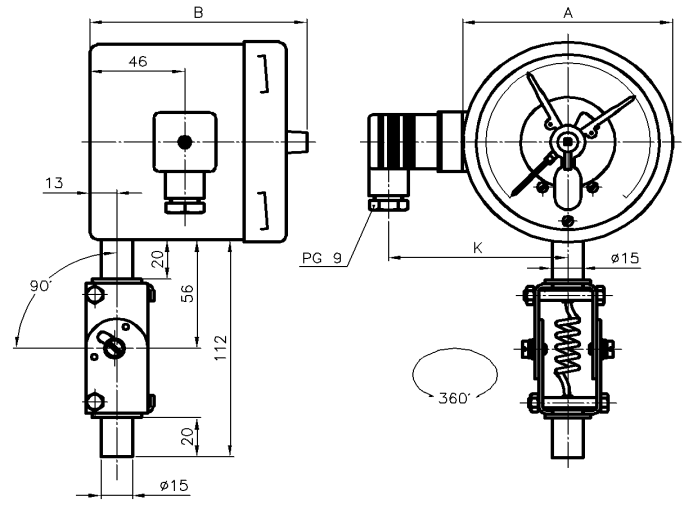
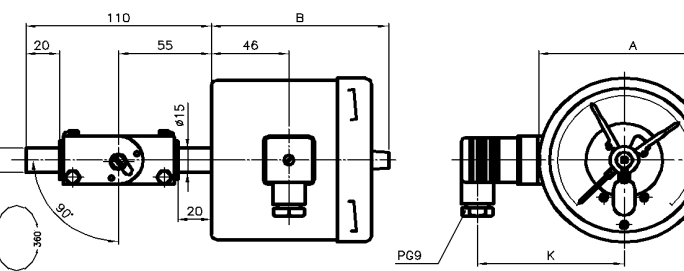
TYPE	DRAWING	DIMENSIONS mm														
<p style="text-align: center;">A</p> <p style="text-align: center;"><i>TXRxxxXA + knee joint 180°</i></p> <p>Hirschman cable junction box</p>		<table border="1"> <thead> <tr> <th rowspan="2">DIM.</th> <th colspan="2">CASE DIAMETER</th> </tr> <tr> <th>100</th> <th>160</th> </tr> </thead> <tbody> <tr> <td>A</td> <td>101</td> <td>161</td> </tr> <tr> <td>B</td> <td>104</td> <td>108</td> </tr> <tr> <td>K</td> <td>92</td> <td>122</td> </tr> </tbody> </table>	DIM.	CASE DIAMETER		100	160	A	101	161	B	104	108	K	92	122
DIM.	CASE DIAMETER															
	100	160														
A	101	161														
B	104	108														
K	92	122														
<p style="text-align: center;">E</p> <p style="text-align: center;"><i>TXRxxxXE + knee joint 180°</i></p> <p>Hirschman cable junction box</p>		<table border="1"> <thead> <tr> <th rowspan="2">DIM.</th> <th colspan="2">CASE DIAMETER</th> </tr> <tr> <th>100</th> <th>160</th> </tr> </thead> <tbody> <tr> <td>A</td> <td>101</td> <td>161</td> </tr> <tr> <td>B</td> <td>104</td> <td>108</td> </tr> <tr> <td>K</td> <td>92</td> <td>122</td> </tr> </tbody> </table>	DIM.	CASE DIAMETER		100	160	A	101	161	B	104	108	K	92	122
DIM.	CASE DIAMETER															
	100	160														
A	101	161														
B	104	108														
K	92	122														
<p style="text-align: center;">A</p> <p style="text-align: center;"><i>TXRxxxXE + knee joint 360°</i></p> <p>Hirschman cable junction box</p>		<table border="1"> <thead> <tr> <th rowspan="2">DIM.</th> <th colspan="2">CASE DIAMETER</th> </tr> <tr> <th>100</th> <th>160</th> </tr> </thead> <tbody> <tr> <td>A</td> <td>101</td> <td>161</td> </tr> <tr> <td>B</td> <td>104</td> <td>108</td> </tr> <tr> <td>K</td> <td>92</td> <td>122</td> </tr> </tbody> </table>	DIM.	CASE DIAMETER		100	160	A	101	161	B	104	108	K	92	122
DIM.	CASE DIAMETER															
	100	160														
A	101	161														
B	104	108														
K	92	122														
<p style="text-align: center;">E</p> <p style="text-align: center;"><i>TXRxxxXE + knee joint 360°</i></p> <p>Hirschman cable junction box</p>		<table border="1"> <thead> <tr> <th rowspan="2">DIM.</th> <th colspan="2">CASE DIAMETER</th> </tr> <tr> <th>100</th> <th>160</th> </tr> </thead> <tbody> <tr> <td>A</td> <td>101</td> <td>161</td> </tr> <tr> <td>B</td> <td>104</td> <td>108</td> </tr> <tr> <td>K</td> <td>92</td> <td>122</td> </tr> </tbody> </table>	DIM.	CASE DIAMETER		100	160	A	101	161	B	104	108	K	92	122
DIM.	CASE DIAMETER															
	100	160														
A	101	161														
B	104	108														
K	92	122														

THERMOMETERS TYPE TXC WITH CONTACT

TYPE	DRAWING	DIMENSIONS mm																																
<p>A</p> <p><i>TXCxxxXA</i></p> <p>Hirschman cable junction box</p>		<table border="1"> <thead> <tr> <th rowspan="2">DIM.</th> <th colspan="2">CASE DIAMETER</th> </tr> <tr> <th>100</th> <th>160</th> </tr> </thead> <tbody> <tr> <td>A</td> <td>101</td> <td>161</td> </tr> <tr> <td>B</td> <td>104</td> <td>108</td> </tr> <tr> <td>K</td> <td>92</td> <td>122</td> </tr> </tbody> </table>	DIM.	CASE DIAMETER		100	160	A	101	161	B	104	108	K	92	122																		
DIM.	CASE DIAMETER																																	
	100	160																																
A	101	161																																
B	104	108																																
K	92	122																																
<p>B</p> <p><i>TXCxxxXB</i></p> <p>Hirschman cable junction box</p>		<table border="1"> <thead> <tr> <th rowspan="2">DIM.</th> <th colspan="2">CASE DIAMETER</th> </tr> <tr> <th>100</th> <th>160</th> </tr> </thead> <tbody> <tr> <td>A</td> <td>101</td> <td>161</td> </tr> <tr> <td>B</td> <td>110</td> <td>114</td> </tr> <tr> <td>C</td> <td>19</td> <td>19</td> </tr> <tr> <td>D</td> <td>132</td> <td>196</td> </tr> <tr> <td>H</td> <td>5.5</td> <td>6</td> </tr> <tr> <td>P</td> <td>116</td> <td>178</td> </tr> <tr> <td>K</td> <td>92</td> <td>122</td> </tr> </tbody> </table>	DIM.	CASE DIAMETER		100	160	A	101	161	B	110	114	C	19	19	D	132	196	H	5.5	6	P	116	178	K	92	122						
DIM.	CASE DIAMETER																																	
	100	160																																
A	101	161																																
B	110	114																																
C	19	19																																
D	132	196																																
H	5.5	6																																
P	116	178																																
K	92	122																																
<p>D</p> <p><i>TXCxxxXD</i></p> <p>Hirschman cable junction box</p>		<table border="1"> <thead> <tr> <th rowspan="2">DIM.</th> <th colspan="2">CASE DIAMETER</th> </tr> <tr> <th>100</th> <th>160</th> </tr> </thead> <tbody> <tr> <td>A</td> <td>101</td> <td>161</td> </tr> <tr> <td>B</td> <td>80</td> <td>83</td> </tr> <tr> <td>C</td> <td>13</td> <td>13</td> </tr> <tr> <td>D</td> <td>132</td> <td>196</td> </tr> <tr> <td>H</td> <td>5.5</td> <td>6</td> </tr> <tr> <td>P</td> <td>116</td> <td>178</td> </tr> <tr> <td>K1</td> <td>92</td> <td>122</td> </tr> <tr> <td>K2</td> <td>15</td> <td>0*</td> </tr> </tbody> </table> <p>* 54 mm to the left (front view)</p>	DIM.	CASE DIAMETER		100	160	A	101	161	B	80	83	C	13	13	D	132	196	H	5.5	6	P	116	178	K1	92	122	K2	15	0*			
DIM.	CASE DIAMETER																																	
	100	160																																
A	101	161																																
B	80	83																																
C	13	13																																
D	132	196																																
H	5.5	6																																
P	116	178																																
K1	92	122																																
K2	15	0*																																
<p>F</p> <p><i>TXCxxxXF</i></p> <p>Hirschman cable junction box</p>		<table border="1"> <thead> <tr> <th rowspan="2">DIM.</th> <th colspan="2">CASE DIAMETER</th> </tr> <tr> <th>100</th> <th>160</th> </tr> </thead> <tbody> <tr> <td>A</td> <td>101</td> <td>161</td> </tr> <tr> <td>B</td> <td>110</td> <td>114</td> </tr> <tr> <td>D</td> <td>132</td> <td>196</td> </tr> <tr> <td>H</td> <td>5.5</td> <td>6</td> </tr> <tr> <td>P</td> <td>116</td> <td>178</td> </tr> <tr> <td>K</td> <td>92</td> <td>122</td> </tr> </tbody> </table>	DIM.	CASE DIAMETER		100	160	A	101	161	B	110	114	D	132	196	H	5.5	6	P	116	178	K	92	122									
DIM.	CASE DIAMETER																																	
	100	160																																
A	101	161																																
B	110	114																																
D	132	196																																
H	5.5	6																																
P	116	178																																
K	92	122																																
<p>G</p> <p><i>TXCxxxXG</i></p> <p>Hirschman cable junction box</p>		<table border="1"> <thead> <tr> <th rowspan="2">DIM.</th> <th colspan="2">CASE DIAMETER</th> </tr> <tr> <th>100</th> <th>160</th> </tr> </thead> <tbody> <tr> <td>A</td> <td>101</td> <td>161</td> </tr> <tr> <td>B</td> <td>80</td> <td>83</td> </tr> <tr> <td>C1</td> <td>26</td> <td>0</td> </tr> <tr> <td>C2</td> <td>10</td> <td>0</td> </tr> <tr> <td>D</td> <td>132</td> <td>196</td> </tr> <tr> <td>H</td> <td>5.5</td> <td>6</td> </tr> <tr> <td>P</td> <td>116</td> <td>178</td> </tr> <tr> <td>K1</td> <td>123</td> <td>126</td> </tr> <tr> <td>K2</td> <td>15</td> <td>0*</td> </tr> </tbody> </table> <p>* 54 mm to the left (front view)</p>	DIM.	CASE DIAMETER		100	160	A	101	161	B	80	83	C1	26	0	C2	10	0	D	132	196	H	5.5	6	P	116	178	K1	123	126	K2	15	0*
DIM.	CASE DIAMETER																																	
	100	160																																
A	101	161																																
B	80	83																																
C1	26	0																																
C2	10	0																																
D	132	196																																
H	5.5	6																																
P	116	178																																
K1	123	126																																
K2	15	0*																																

THERMOMETERS TYPE TXC WITH CONTACT

TYPE	DRAWING	DIMENSIONS mm																													
H <i>TXCxxxXH</i> Hirschman cable junction box		<table border="1"> <thead> <tr> <th rowspan="2">DIM.</th> <th colspan="2">CASE DIAMETER</th> </tr> <tr> <th>100</th> <th>160*</th> </tr> </thead> <tbody> <tr> <td>A</td> <td>101</td> <td>161</td> </tr> <tr> <td>B</td> <td>84</td> <td>88</td> </tr> <tr> <td>C</td> <td>25</td> <td>0</td> </tr> <tr> <td>D</td> <td>112</td> <td>180</td> </tr> <tr> <td>E</td> <td>109</td> <td>113</td> </tr> <tr> <td>P</td> <td>75</td> <td>139</td> </tr> <tr> <td>K1</td> <td>128</td> <td>131</td> </tr> <tr> <td>K2</td> <td>15</td> <td>54**</td> </tr> </tbody> </table> <p>* U-clamp mounted vertical ** 54 mm to the left (front view)</p>	DIM.	CASE DIAMETER		100	160*	A	101	161	B	84	88	C	25	0	D	112	180	E	109	113	P	75	139	K1	128	131	K2	15	54**
		DIM.		CASE DIAMETER																											
100	160*																														
A	101	161																													
B	84	88																													
C	25	0																													
D	112	180																													
E	109	113																													
P	75	139																													
K1	128	131																													
K2	15	54**																													
I <i>TXCxxxXI</i> Hirschman cable junction box		<table border="1"> <thead> <tr> <th rowspan="2">DIM.</th> <th colspan="2">CASE DIAMETER</th> </tr> <tr> <th>100</th> <th>160</th> </tr> </thead> <tbody> <tr> <td>A</td> <td>101</td> <td>161</td> </tr> <tr> <td>B</td> <td>104</td> <td>108</td> </tr> <tr> <td>K</td> <td>92</td> <td>122</td> </tr> </tbody> </table>	DIM.	CASE DIAMETER		100	160	A	101	161	B	104	108	K	92	122															
		DIM.		CASE DIAMETER																											
100	160																														
A	101	161																													
B	104	108																													
K	92	122																													

THERMOMETERS TYPE TPC WITH CONTACT

S <i>TPCxxxXS</i> Hirschman cable junction box		<table border="1"> <thead> <tr> <th rowspan="2">DIM.</th> <th colspan="2">CASE DIMENSIONS</th> </tr> <tr> <th>96x96</th> <th>144x144</th> </tr> </thead> <tbody> <tr> <td>A</td> <td>90x90</td> <td>183x183</td> </tr> <tr> <td>B</td> <td>99</td> <td>136</td> </tr> <tr> <td>C1</td> <td>25</td> <td>0</td> </tr> <tr> <td>C2</td> <td>11</td> <td>0</td> </tr> <tr> <td>D</td> <td>96x96</td> <td>144x144</td> </tr> <tr> <td>K1</td> <td>142</td> <td>180</td> </tr> <tr> <td>K2</td> <td>18</td> <td>16</td> </tr> <tr> <td>K3</td> <td>27</td> <td>41</td> </tr> </tbody> </table>	DIM.	CASE DIMENSIONS		96x96	144x144	A	90x90	183x183	B	99	136	C1	25	0	C2	11	0	D	96x96	144x144	K1	142	180	K2	18	16	K3	27	41
		DIM.		CASE DIMENSIONS																											
96x96	144x144																														
A	90x90	183x183																													
B	99	136																													
C1	25	0																													
C2	11	0																													
D	96x96	144x144																													
K1	142	180																													
K2	18	16																													
K3	27	41																													
H / V <i>TPCxxxXH</i> <i>TPCxxxXV</i> Hirschman cable junction box		<table border="1"> <thead> <tr> <th rowspan="2">DIM.</th> <th colspan="2">CASE DIMENSIONS</th> </tr> <tr> <th colspan="2">72x144</th> </tr> </thead> <tbody> <tr> <td>A</td> <td colspan="2">66x136</td> </tr> <tr> <td>B</td> <td colspan="2">130</td> </tr> <tr> <td>C1</td> <td colspan="2">32</td> </tr> <tr> <td>D</td> <td colspan="2">72X144</td> </tr> <tr> <td>K1</td> <td colspan="2">173</td> </tr> <tr> <td>K2</td> <td colspan="2">26</td> </tr> <tr> <td>K3</td> <td colspan="2">11</td> </tr> </tbody> </table>	DIM.	CASE DIMENSIONS		72x144		A	66x136		B	130		C1	32		D	72X144		K1	173		K2	26		K3	11				
		DIM.		CASE DIMENSIONS																											
72x144																															
A	66x136																														
B	130																														
C1	32																														
D	72X144																														
K1	173																														
K2	26																														
K3	11																														

BUILT-IN PT-100 / TRANSMITTERS

With PT-100 sensor

SENSOR	: PT-100
ACCURACY	: 1/3 DIN class B, IEC751
INSTRUMENT	: class 1
MINIMAL RANGE	: 60 °C
BULB SIZE	: minimal Ø8 mm
CONNECTOR	: cable junction box, SEE BELOW



TYPE	FUNCTION	CABLE JUNCTION BOX	CASE DIMENSIONS				
			100	160	96x96	144x144	72x144
PT-100	PT-100 sensor 3 wire	<p>Wiebrock</p>	first 100 m bulb per 100 mm extra First 1000 mm capillary per 1000 mm extra:				
TT2	4...20 mA, 13...35Vdc, 2-wire		excluding PT-100 sensor				
TRP-EX	4...20 mA, 13...35Vdc, 2-wire EEx ib II C T6	depends on design	excluding PT-100 sensor				

With potentiometer

TYPE	FUNCTION	CABLE JUNCTION BOX	CASE DIMENSIONS				
			100	160	96x96	144x144	72x144
RT43	4...20 mA, 13...35Vdc, 3-wire	<p>Hirschmann</p>					N.A.
RT03	0...20 mA, 13...35Vdc, 3-wire						N.A.
R	0...100 ohm, 3-wire						N.A.

ADD-ON UNITS WITH ELECTRICAL CONTACTS FOR THERMOMETERS

ADD-ON UNIT (built on top of dial) with PG cable conduit and 1500 mm cable			
DIN16085/16196 TYPE	Switch function in clockwise direction	EXTRA COSTS	
		CASE DIMENSIONS (in mm)	
STANDARD ADD-ON CONTACT (=10W/~18VA), TYPE: S		Ø 100	Ø 160
S -1	contact closes		
S -2	contact opens		
S -3	single change-over contact (SPDT)		
S -11	1st contact closes, 2nd contact closes		
S -12	1st contact closes, 2nd contact opens		
S -21	1st contact opens, 2nd contact closes		
S -22	1st contact opens, 2nd contact opens		
S -xx+GS	double acting contact with separate circuits		
S -xxx	triple acting contact, 1=closes, 2=opens		
MAGNETIC ADD-ON CONTACT (=30W/~50VA), TYPE: M		Ø 100	Ø 160
M -1	contact closes		
M -2	contact opens		
M -3	single change-over contact (SPDT)		
M -11	1st contact closes, 2nd contact closes		
M -12	1st contact closes, 2nd contact opens		
M -21	1st contact opens, 2nd contact closes		
M -22	1st contact opens, 2nd contact opens		
M -xx+GS	double acting contact with separate circuits		
M -xxx	triple acting contact, 1=closes, 2=opens		
INDUCTIVE ADD-ON CONTACT (=8V, Ri=1 kohm, EEx ib IIC T6), TYPE: I		Ø 100	Ø 160
I -1	contact closes (operating current)		
I -2	contact opens		
I -x+SN	single contact with safety oscillator (SN)		
I -11	1st contact closes, 2nd contact closes		
I -12	1st contact closes, 2nd contact opens		
I -21	1st contact opens, 2nd contact closes		
I -22	1st contact opens, 2nd contact opens		
I -xx+SN	double contact with safety oscillator (SN)		

OPTIONS FOR ELECTRICAL CONTACTS

OPTIONS	DESCRIPTION	Ø 100	Ø 160	96 x 96	144 x 144	72 x 144
OIL FILLING	for HZ electrical contacts only			N.A.	N.A.	N.A.
CABLE	Cable connected to junction box for HZ electrical contacts	First 1500 mm:		per 1000 mm extra:		
MSR-010	Protection relay for single acting contacts (supply 220Vac)					
MSR-020	Protection relay for double acting contacts (supply 220Vac)					
WE 77/Ex-1	Protection relay for single inductive contacts Eex ia ib IIC					
WE 77/Ex-2	Protection relay for double inductive contacts Eex ia ib IIC					

STAINLESS STEEL POCKETS (WELDED)

WELDED POCKETS (THREADED), $P_{max} = 25 \text{ bar}$

STANDARD MODEL:

MATERIAL

: AISI304/1.4301, AISI321/1.4541

CONNECTION FOR TYPE 02; 04

: 1/2" BSP, type B, see page 8, 25

CONNECTION FOR TYPE 03; 04

: 1/2" BSP, type A04 or CSx see page 8, 9, 25, 26

OPTIONS

: other stem diameters

others threads

Type 02



THREADED TYPE		STANDARD DIMENSIONS (in mm)										COSTS	per 100 mm extra
02	03	bulb dia.	L pocket	d1	d2	d3	T	D	HEX-1	HEX-2			
<p>$L1 = L\text{-pocket} + 20 \text{ mm}$</p>	<p>For type CS1, 2, 3 $L1 = L\text{-pocket} + 10 \text{ mm}$</p> <p>For type A04 $L1 = L\text{-pocket}$</p>	10	100	1/2" BSP	1/2" BSP	10.5	14	12.5	22	27			
		10	100	1/2" BSP	3/4" BSP	10.5	16	12.5	27	32			
		10	100	1/2" BSP	1" BSP	10.5	18	12.5	36	36			
		10	100	1/2" BSP	1/2" NPT	10.5	20	12.5	22	27			
		10	100	1/2" BSP	3/4" NPT	10.5	20	12.5	27	27			
		10	100	1/2" BSP	1" NPT	10.5	25	12.5	36	36			
		10	100	1/2" BSP	M20x1.5	10.5	14	12.5	22	27			
		10	100	1/2" BSP	M24x1.5	10.5	14	12.5	27	27			
		12,5	63	1/2" BSP	1/2" BSP	13	14	15	22	27			
		12,5	63	1/2" BSP	3/4" BSP	13	16	15	27	32			
		12,5	63	1/2" BSP	1" BSP	13	18	15	36	36			
		12,5	63	1/2" BSP	1/2" NPT	13	20	15	22	27			
		12,5	63	1/2" BSP	3/4" NPT	13	20	15	27	27			
		12,5	63	1/2" BSP	1" NPT	13	25	15	36	36			
12,5	63	1/2" BSP	M24x1.5	13	14	15	27	27					

WELDING TYPE		STANDARD DIMENSIONS (in mm)										COSTS	per 100 mm extra
04	05	bulb dia.	L pocket	d1	d2	d3	T	D	HEX-1	HEX-2			
<p>$L1 = L\text{-pocket} + 20 \text{ mm}$</p>	<p>For type CS1, 2, 3 $L1 = L\text{-pocket} + 10 \text{ mm}$</p> <p>For type A04, $L1 = L\text{-pocket} + 10 \text{ mm}$</p>	10	100	1/2" BSP	18	10.5	14	12.5	22	27			
		10	100	3/4" BSP	23	10.5	16	12.5	27	32			
		10	100	1" BSP	28	10.5	18	12.5	36	36			
		12,5	63	1/2" BSP	18	13	14	15	22	27			
		12,5	63	3/4" BSP	23	13	16	15	27	32			
		12,5	63	1" BSP	28	13	18	15	36	36			

OTHER DESIGNS, BULB DIAMETERS AND MATERIALS ON DEMAND
MATERIAL CERTIFICATE ACC TO EN 10204 3.1.B. see page 29

STAINLESS STEEL THERMOWELL (BAR STOCK)

Weld - in thermowell form BS and CS acc. to DIN 16179

STANDARD MODEL:

MATERIAL : AISI316Ti/1.4571, others on request
INSTRUMENT CONNECTION : 1/2"BSP
FORM BD, BE, CD, CE : on request
OPTIONS : other materials
 others instruments threads

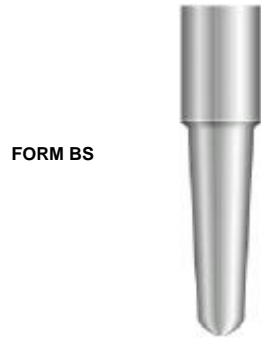

FORM BS

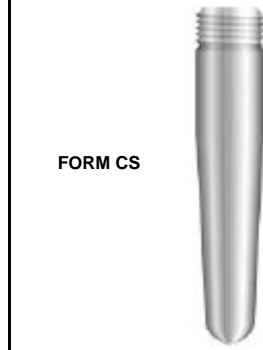

FORM CS

THERMOWELLS ACC. TO:

DIN 43763 (D1 - D6) AND DIN 43772-2 (FORM 4 - 9) ON REQUEST

WELDING TYPE	STANDARD DIMENSIONS (in mm)											COSTS
	bulb dia.	L2	d1	d5	d6	d7	b1	h6	r2	r3	t1	
	10	73	1/2"BSP	30	25	11	16	39	2,5	8,5	20	
	10	133	1/2"BSP	30	25	11	16	39	2,5	8,5	20	
	10	223	1/2"BSP	30	25	11	16	39	2,5	8,5	20	
	12	73	1/2"BSP	30	25	13	16	39	2,5	9,5	20	
	12	133	1/2"BSP	30	25	13	16	39	2,5	9,5	20	
	12	223	1/2"BSP	30	25	13	16	39	2,5	9,5	20	
	12	373	1/2"BSP	30	25	13	16	39	2,5	9,5	20	
L-thermometer	for connection type AL04			L-thermometer = L2 + 10 mm								
	for connection type CS1, 2, 3			L-thermometer = L2 + 30 mm								
	10	63	1/2"BSP	11	24	12	39	8,5				
	10	100	1/2"BSP	11	24	12	39	8,5				
	10	160	1/2"BSP	11	24	12	39	8,5				
	10	250	1/2"BSP	11	24	12	39	8,5				
	12	63	1/2"BSP	13	30	14	45	9,5				
	12	100	1/2"BSP	13	30	14	45	9,5				
	12	160	1/2"BSP	13	30	14	45	9,5				
	12	250	1/2"BSP	13	30	14	45	9,5				
	12	400	1/2"BSP	13	30	14	45	9,5				
L-thermometer	for connection type B			L-thermometer = L2 + h6 - 10 mm								

MATERIAL CERTIFICATE ACC TO EN 10204 3.1.B. see page 29

STAINLESS STEEL THERMOWELL (BAR STOCK)

Screw - in thermowell form BE and CE acc. to DIN 16179

STANDARD MODEL:

MATERIAL : AISI316Ti/1.4571, others on request
INSTRUMENT CONNECTION : 1/2"BSP
FORM BD, CD : on request
OPTIONS : other materials
 others proces / instruments threads

FORM BE



FORM CE



THERMOWELLS ACC. TO:

DIN 43763 (D1 - D6) AND DIN 43772-2 (FORM 4 - 9) ON REQUEST

THREADED TYPE	STANDARD DIMENSIONS (in mm)																COSTS
BE	bulb dia.	L2	d1	d2	d3	d4	d7	b1	h3	h4	h5	i1	r1	r3	t1	SW	
	10	87	1/2"BSP	26	27	17	11	16	22	12	25	14	1.6	8.5	20	27	
	10	147	1/2"BSP	26	27	17	11	16	22	12	25	14	1.6	8.5	20	27	
	10	237	1/2"BSP	26	27	17	11	16	22	12	25	14	1.6	8.5	20	27	
	12	87	1/2"BSP	26	27	17	13	16	22	12	25	14	1.6	9.5	20	27	
	12	147	1/2"BSP	26	27	17	13	16	22	12	25	14	1.6	9.5	20	27	
	12	237	1/2"BSP	26	27	17	13	16	22	12	25	14	1.6	9.5	20	27	
	12	387	1/2"BSP	26	27	17	13	16	22	12	25	14	1.6	9.5	20	27	
L-thermometer	for connection type AL04						L-thermometer = L2 - 5 mm										
	for connection type CS1, 2, 3						L-thermometer = L2 + 15 mm										
CE	bulb dia.	L2	d1	d2	d4	d7	h2	h5	i1	r1	r3	SW	COSTS				
	10	63	1/2"BSP	26	17	11	12	25	14	1.6	8.5	27					
	10	100	1/2"BSP	26	17	11	12	25	14	1.6	8.5	27					
	10	160	1/2"BSP	26	17	11	12	25	14	1.6	8.5	27					
	10	250	1/2"BSP	26	17	11	12	25	14	1.6	8.5	27					
	12	63	1/2"BSP	26	17	13	12	25	14	1.6	9.5	27					
	12	100	1/2"BSP	26	17	13	12	25	14	1.6	9.5	27					
	12	160	1/2"BSP	26	17	13	12	25	14	1.6	9.5	27					
	12	250	1/2"BSP	26	17	13	12	25	14	1.6	9.5	27					
	12	400	1/2"BSP	26	17	13	12	25	14	1.6	9.5	27					
L-thermometer	for connection type B						L-thermometer = L2 + 15 mm										

MATERIAL CERTIFICATE ACC TO EN 10204 3.1.B. see page 29

STAINLESS STEEL THERMOWELL (BAR STOCK)

Flanged thermowell acc. to DIN or ANSI

STANDARD MODEL:

MATERIAL : AISI316Ti/1.4571, others on request

CONSTRUCTION : barr stock + welded flange

OPTIONS : other dimensions / bulb sizes
other flanges DN / PN
others instruments threads



THERMOWELLS ACC. TO:

DIN 43763 (D1 - D6) AND DIN 43772-2 (FORM 4 - 9) ON REQUEST

FLANGED TYPE						DIAMETER / CONNECTION DIM. (mm)						LENGTH DIM. (mm)				
DIN FLANGE						d1	F2	N	F3	H1	H2	L	G	U	U1	
DN	PN	D	k	b	d2											
20	40	105	75	14	4x14	7	24	M18x1.5	12.5	14	12	110	105	65	--	
25		115	85	14	4x14			9		1/2"BSP (M20x1.5)	15	15	170	165	125	--
32		140	100	18	4x18				11		3/4"BSP (M27x2)		17	19	200	195
40		150	110	18	4x18	13	32	19		17		260	255	125	190	
50		165	125	18	4x18			14	20		19	17	410	405	275	340
65		185	145	18	8x18						OTHERS ON REQUEST					
ANSI FLANGE																
DN	PN	D	k	b	d2											
3/4"	150#	98.4	69.8	1/2"	4x15.9											
1"		107.9	79.4	9/16"	4x15.9											
1 1/4"		117.5	88.9	5/8"	4x15.9											
1 1/2"		127	98.4	11/16"	4x15.9											
2"		152.4	120.6	3/4"	4x19											
2 1/2"		177.8	139.7	7/8"	4x19											
L-thermometer						for connection type AL04				L-thermometer = L - 30 mm						
						for connection type CS1, 2, 3				L-thermometer = L - 10 mm						

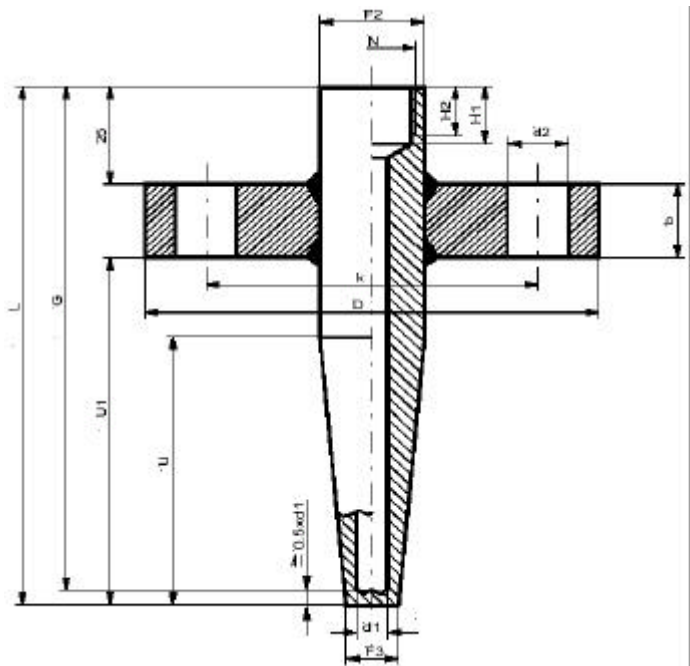

MATERIAL CERTIFICATE ACC TO EN 10204 3.1.B. see page 29
OTHER DIMENSIONS / MATERIALS ON REQUEST